

# ENHANCING LINE EFFICIENCY OF ROAD MACHINERY ASSEMBLY LINE AT VOLVO CONSTRUCTION EQUIPMENT

Bharatesh R B<sup>1</sup>, Dr. M. Rajesh<sup>2</sup>, Dr. M R Shivakumar<sup>3</sup>

<sup>1</sup>M. Tech Student, Industrial Engineering, Ramaiah Institute of Technology, Karnataka, India

<sup>2</sup>Associate Professor, Industrial Engineering, Ramaiah Institute of Technology, Karnataka, India

<sup>3</sup>Assistant Professor, Industrial Engineering, Ramaiah Institute of Technology, Karnataka, India

\*\*\*

**Abstract** - This project addresses on enhancing the line efficiency of assembly line issue through the application of assembly line balancing technique. Assembly Lines are flow oriented production system in which the number of stations arranged and jobs are moving from station to station in a sequential manner without violating the precedence and cycle time requirement until the production of final product. In this project assembly line of road machinery of VOLVO CE, Bengaluru is considered. The focus of the project is on enhancement of efficiency of assembly line through minimizing the number of workstations and thereby reducing balance delay.

- 2) Tanks and Swivel Frame Installation
- 3) Engine Installation
- 4) Battery and Silencer Installation
- 5) Cowling, Hood and Hydraulic Piping Installation
- 6) Drum Frame, Rops and Railing Installation
- 7) Scrapper, Tyre, Electrical Battery Routing Installation



Figure 1.9: Models assembled

**Key Words:** Assembly line, Line balancing, line efficiency, Heuristic Methods, Time Study and Road Machinery.

## 1. INTRODUCTION

Assembly line of road machinery consist of SEVEN main stations and NINE feeder stations. The main stations are provided by the subassemblies by the use of feeders. The process flow diagram is shown in Figure 1.8.

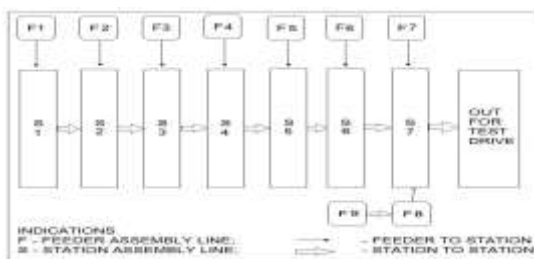

Figure 1.8: Layout of Road Machinery assembly line

The nine feeder stations are:

- 1) Axle Sub Assembly Area
- 2) Tank Sub Assembly Area
- 3) Engine Sub Assembly Area
- 4) Console Sub Assembly Area
- 5) Hood Sub Assembly Area
- 6) Drum Frame & Exhaust Sub Assembly Area
- 7) Rops, Scrapper, Tyres
- 8) Drum Cell
- 9) Drum Sub Line

The seven main stations are:

- 1) Main Frame and axle Installation

## 2. PROBLEM IDENTIFICATION

In today's market price customer are most demanding customers are looking for high quality of products which will fit for their purpose and below response time with the lowest possible cost this makes manufacturers to produce the products by considering customers requirement right from the first step to last step of production of product manufacturer uses mass customization concept for production of variety of products that are able to fulfill the demands of customers in a practice manufacturers face difficulties while producing products that are able to meet customer demands at same profit level.

Assembling are important to manufacturing products which are capable of meeting the customer's demand assembly line are very much important from point of view of manufacturers in more bottlenecks competitive world manufacturing the products because assembly line are one through which they can able to assemble different parts to make one complete machine or structure one unit of product so the products can be delivered at the faster response time with appropriate quality and quantity to the customer. One of the main hurdles to produce products and delivering it to the customer at faster response time to customer is inefficient assembly lines. For the purpose of the study of road machinery assembly line which is used for assembling compactors of Volvo construction equipment Bengaluru is considered the concentration of study is on mixed model assembly the study of mixed model assembly line is taken for this project in order to find the way in which the efficiency of assembly line can be improved by helping to Volvo

construction equipment to deliver the models at faster response time along with proper quality to customer.

The Problem definition is as follows

“ENHANCING LINE EFFICIENCY OF ROAD MACHINERY ASSEMBLY LINE”

#### **Objective:**

1) To determine efficiency of assembly line of the mixed models of road machinery of present layout.

2) Improve the line efficiency by using Line Balancing Techniques.

### **3. METHOD AND ANALYSIS**

#### **3.1 Time Study**

The study is defined as work measurement technique for obtaining the time measurement and rate task working of specified job done under specified condition. In another word time study is the study about the task in order to obtain the required time for completion of task. Time study is done with the help of timekeeping devices such as stopwatch videotape camera computer assist electronic stopwatch through continuous and direct observation of task that needs to be time studied.

Time study work measurement technique to estimate time required for normal qualified worker to carry out the job at normal pace by using specified method.

Prerequisites for time study are as follows:

- a) The task or operation selected for time study should be performed with standard tools equipment and material.
- b) The worker selected for observation to obtain time standards for particular job should be average performer that is the worker should be representative of all workers.
- c) The operation should be performed with the standard method specified by the method study department

Application of time study for setting standard and planning and control the work was introduced by FW Taylor a father of scientific management. Taylor had his colleague proposed which contain giant performance standard with use of scientific time study. The reason behind time study method proposed by Taylor was that he wanted to maximize productivity.

#### **3.2 Heuristic Technique of Line Balancing**

The meaning of heuristic is “serving to find out”, in other words heuristic method are used for finding out discover things for oneself. Heuristic specifies a particular approach for solving the problems, it helps in decision making and control over the situation. These techniques are simple and they serve as thumb rule for solving complex

problems. Objective is to provide the ways for solving problem, which will help for recovery. As logical analysis one can use common sense logic and beyond this past experience to tackle with new problem while implementing heuristic method. Elastic technique may not give the optimal solution to the problem but they provide most likely solution for problems which are good enough for practical point of view.

Heuristic techniques are preferred for solving assembly line balancing problem. This approach for solving the problem has advantage of speed, cost consistency and ability to cope with large amount of data and it is preferable when it is more difficult to get the better feasible solution for complex general assembly line balancing problems in industries.

The main heuristic technique for assembly line balancing problems is as follows:

- 1) Ranked Positional Weight method (RPW)
- 2) Largest Candidate Rule method (LCR)
- 3) Kilbridge and Wester Column method (KWC)

#### **1) Ranked Positional Weight (RPW) method**

This method takes into account the precedence relationships as well as processing time of all tasks. Ranked positional weight for each task is obtained by considering the task time and task position in precedence diagram, then task are assigned to the each station in descending order for ranked positional weights.

Steps for solving assembly line balancing problem by using RPW method are as follows:

- 1) Draw the precedence diagram.
- 2) Calculate ranked positional weight (RPW). Rank positional weight of task is its own time and duration of all succeeding tasks in precedence diagram.
- 3) Arrange the task in descending order of rank positional rates.
- 4) Assign task to the number of workstations. Assignment of task to the workstation should be in such a way that it should satisfy the precedence requirement and without violating cycle time constraints.
- 5) Repeat the above step until all task in precedence diagram are assigned to stations.
- 6) Calculate the line efficiency, balance delay and smoothness index.

#### **2) Largest Candidate Rule (LCR) method**

This method is one of the easiest compared to other methods. LCR method take into account only task time, allocating the task to the workstations. The basic principle is to combine the processes of sorting operation on the basis of the largest processing time to smallest elements of the operating time.

Procedure for applying the LCR to solve the assembly line balancing problem is as follows:

- 1) Arrange the task elements in descending order of their completion time.
- 2) Allocate the task to the number of workstations such that precedence and cycle time constraints satisfied with the assignment of task to the workstation.
- 3) Repeat the above step until all tasks have been allocated to the number of workstations.
- 4) Calculate the line efficiency, balance delay and smoothness index.

3) Kilbridge and Wester Column (KWC) method

Kilbridge and Wester Column method can be applied to solve complicated problems of assembly line balancing. While applying KWC method to solve the assembly line balancing problem task assigned based on their position in precedence diagram by doing this one can be able to overcome the difficulties that are faced while applying LCR, that is if one completion time of the end task is larger than another task it may result in assigning the end task fast.

Procedure for solving the assembly line balancing problem with the help of this method is as follows:

- 1) Construct the precedence diagram. Arrange the notes representing the task into number of columns.
- 2) Task in the column are assigned to workstation in such a way that satisfies the cycle time and precedence requirement restrictions.
- 3) Repeat above step until all tasks have been assigned to number of workstations.
- 4) Calculate the line efficiency, balance delay and smoothness index.

**4. DATA COLLECTION AND CALCULATION**

The data about the sequence of order in which the task performed among the feeders, main stations are noted and time required for performing this task is collected and tabulated. Analyzing of tabulated data is carried through the application of heuristic methods of line balancing.

For analysis purpose below formula are used:

$$\text{Line Efficiency} = \frac{\text{Total Task Time (station Time)}}{\text{Actual Number of Workstation} \times \text{Largest Assigned Cycle Time}}$$

$$LE = \frac{\sum_{i=1}^N ST_i}{m \times CT}$$

Where,

$$CT = \text{Cycle Time} = \frac{\text{Total available Production Time}}{\text{Total Number of Units to be Produced}}$$

LE = Line Efficiency

ST = Station Time

m = Number of Stations = N

$$n_{th} = \text{Theoretical number of work station} = \frac{\text{Sum of talk time}}{CT}$$

BD=1-LE

Where,

BD = Balance Delay

LE = Line Efficiency

$$SI = \sqrt{\sum_{i=1}^N (ST_{max} - ST_i)^2}$$

Where,

SI = Smoothness Index

**4.1 Data collection of SD110 compactor for present assembly line**

Activities time and precedence relationships as per the present assembly line of Single Drum Compactor (SD110) is shown in the below Table 4.1

Table 4.1: Precedence Table

ACTIVITY NO	ACTIVITY DESCRIPTION	TIME (Min)	PREDECESSOR
1	Start (SD110)	0	---
2	Main Frame and valve installation	156.9	1
3	Hydraulic & Fuel Tank Sub Assembly	25.82	1
4	Swivel Frame Sub Assembly	9.91	1
5	Engine Sub Assembly	133.76	1
6	Console Sub Assembly	107.43	1
7	Cowling & Hood Sub assembly	35.2	1
8	Control Box Sub Assembly	44.8	1
9	Sunshade Sub Assembly	16.04	1
10	Drum Frame Sub Assembly	5.25	1
11	Drum Sub Assembly	91.88	1
12	Axle sub assembly	27.06	2
13	Axle installation	11.52	2
14	Number Plate Installation	13.3	2
15	Hose installation	7.12	12,13,14
16	Hydraulic & Fuel Tank installation	70.57	3,15
17	Swivel Frame Sub Assembly installation	80.02	4,15
18	Hose Installation	37.29	16,17
19	Engine Installation	15.36	5,18
20	Mud Filter Installation	11.55	19
21	Cooler Installation	101.94	19
22	Recovery Bottle Installation	7.06	19
23	Air Inlet Installation	31.52	19
24	Exhaust System Installation	150.64	19
25	Hose Installation	23.37	20,21,22,23,24
26	Console Installation	48.19	6,25
27	Hose Installation	127.03	26
28	Cowling & Hood Sub assembly Installation	68.19	7,27
29	Control Box Sub Assembly installation	13.93	8,27
30	Hose Installation	34.5	28,29

31	Sunshade Sub Assembly installation	16.67	9,30
32	Drum Frame Sub Assembly installation	24.12	10,31
33	Wheel Installation	36.53	13
34	Drum Assembly	93.11	11
35	Drum Installation	35.3	32,33,34
36	Bumper Installation	34.1	35

= 52.51%

Balance Delay = BD=1-LE

BD=1-0.5251

= 0.4748

= 47.48%

$$SI = \sqrt{\sum_{i=1}^N (ST_{max} - ST_i)^2}$$

Smoothness Index =

$$SI = \sqrt{[(475.2-215.9)]^2 + [(475.2-223.61)]^2 + \dots + [(475.2-62.08)]^2 + [(475.2-290.92)]^2}$$

SI=318.11

Precedence diagram for present assembly line of SD110 compactor: Below Figure 4.1 shows the precedence diagram for single drum compactor assembly line of SD110 compactor. The precedence diagram is drawn as per the precedence relationship among the various activities.

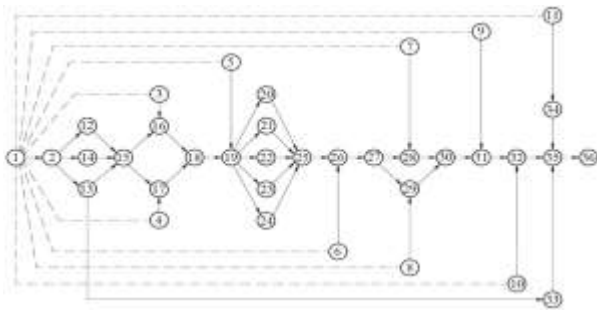

Figure 4.1: Precedence Diagram

Station time at present assembly line: Activities in each station and the total station time is tabulated in the Table 4.2

Table 4.2: Station time and its activities

Activities	Station	Station Time (Min)
1, 2, 12, 13, 14, 15	I	215.9
3, 4, 16, 17, 18	II	223.61
5, 19, 20, 21, 22, 23, 24, 25	III	475.2
6, 26, 27	IV	282.65
7, 8, 28, 29, 30	V	196.62
9, 10, 31, 32	VI	62.08
11, 33, 34, 35, 36	VII	290.92
<b>Total Station Time</b>		<b>1746.98</b>

Calculations for present assembly line of SD110 compactor

Summary of data:

Sum of talk time/ Station time

=215.9+223.61+475.2+282.65+196.62+62.08+290.92 = 1746.98

Governing element = 475.2

$\eta_{th} = (\text{Sum of talk time})/CT$

$\eta_{th} = 1746.98/475.2 = 3.67 \sim 4$

Theoretical number of stations ( $\eta_{th}$ ) = 4

Actual number of stations (m) = 7

Line Efficiency =  $LE = \frac{\sum_{i=1}^N ST_i}{m \times CT}$

LE=1746.98/ (7×475.2)

= 0.5251

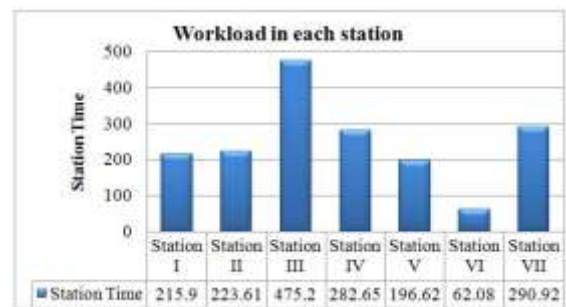

Figure 4.2: Workload distribution of stations

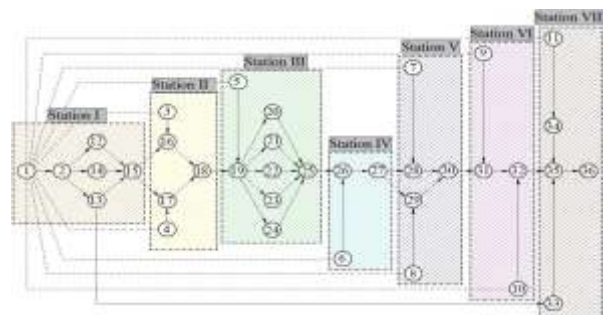

Figure 4.3: Precedence Diagram showing stations



Figure 4.4: Configuration of present assembly line (SD110)

**Analysis by Ranked Positional Weight (RPW) method**

From the collected data Ranked Positional Weight is found and tabulated in Table 4.3

Table 4.3: Calculated RPWs for activities

ACTIVITY NO	TIME (Min)	RPW	PREDECESSOR
1	0	1746.98	---
2	156.9	1183.78	1
3	25.82	877.15	1
4	9.91	870.69	1
5	133.76	877.23	1
6	107.43	509.46	1
7	35.2	248.08	1
8	44.8	203.42	1

9	16.04	126.23	1
10	5.25	98.77	1
11	91.88	254.39	1
12	27.06	965.53	2
13	11.52	986.52	2
14	13.3	951.77	2
15	7.12	938.47	12,13,14
16	70.57	851.33	3,15
17	80.02	860.78	4,15
18	37.29	780.76	16,17
19	15.36	743.47	5,18
20	11.55	436.95	19
21	101.94	527.34	19
22	7.06	432.46	19
23	31.52	456.92	19
24	150.64	576.04	19
25	23.37	425.4	20,21,22,23,24
26	48.19	402.03	6,25
27	127.03	353.84	26
28	68.19	212.88	7,27
29	13.93	158.62	8,27
30	34.5	144.69	28,29
31	16.67	110.19	9,30
32	24.12	93.52	10,31
33	36.53	105.93	13
34	93.11	162.51	11
35	35.3	69.4	32,33,34
36	34.1	34.1	35

All the activities are arranged as per Ranked Positional Weight method and assigned to stations which is shown in the Table 4.4

Table 4.4: Activities assigned to stations as per RPW method

ACTIVITY NO	TIME (Min)	RPW	PREDECESSOR	STATION	STATION TIME		
1	0	1746.9	---	I	470.66		
2	156.9	1183.7	1				
13	11.52	986.52	2				
12	27.06	965.53	2				
14	13.3	951.77	2				
15	7.12	938.47	12,13,14				
5	133.7	877.23	1				
3	25.82	877.15	1				
4	9.91	870.69	1				
17	80.02	860.78	4,15				
10	5.25	98.77	1				
16	70.57	851.33	3,15	II	465.34		
18	37.29	780.76	16,17				
19	15.36	743.47	5,18				
24	150.6	576.04	19				
21	101.9	527.34	19				
23	31.52	456.92	19				
20	11.55	436.95	19				
22	7.06	432.46	19				
25	23.37	425.4	20,21,22,23,24				
9	16.04	126.23	1				
6	107.4	509.46	1	III	468.46		
26	48.19	402.03	6,25				
27	127.0	353.84	26				
11	91.88	254.39	1				
7	35.2	248.08	1				
8	44.8	203.42	1				
29	13.93	158.62	8,27				
28	68.19	212.88	7,27				
35	35.3	69.4	32,33,34			IV	342.52
36	34.1	34.1	35				

34	93.11	162.51	11
30	34.5	144.69	28,29
31	16.67	110.19	9,30
33	36.53	105.93	13
32	24.12	93.52	10,31
35	35.3	69.4	32,33,34
36	34.1	34.1	35

Calculations:

Summary of data:

Sum of Talk Time = 1746.98

Governing element = 470.66

$$\eta_{th} = (\text{Sum of talk time}) / CT$$

$$\eta_{th} = 1746.98 / 470.66 = 3.71 \sim 4$$

Theoretical number of stations ( $\eta_{th}$ ) = 4

Number of stations as per RPW Method (m) = 4

$$\text{Line Efficiency} = LE = \frac{\sum_{i=1}^N ST_i}{m \times CT}$$

$$LE = 1746.98 / (4 \times 470.66)$$

$$= 0.9279$$

$$= 92.79\%$$

Balance Delay = BD = 1 - LE

$$BD = 1 - 0.9279$$

$$= 0.0720$$

$$= 7.2\%$$

$$SI = \sqrt{\sum_{i=1}^N (ST_{max} - ST_i)^2}$$

Smoothness Index =

$$SI = \sqrt{((0))^2 + ((470.66 - 465.34))^2 + ((470.66 - 468.46))^2 + ((470.66 - 342.52))^2}$$

$$SI = 128.26$$

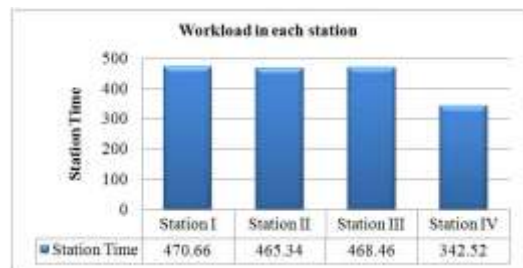

Figure 4.5: Workload distribution of stations as per RPW method

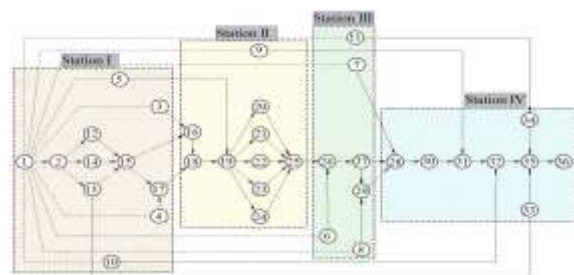

Figure 4.6: Precedence Diagram as per RPW method



Figure 4.7: Configuration of stations as per RPW method

**Analysis by Largest Candidate Rule (LCR) method**

All the activities are arranged as per Largest Candidate Rule which is shown in Table 4.5

Table 4.5: Activities arranged as per LCR method

ACTIVITY NO	TIME (Min)	PREDECESSOR
2	156.9	1
24	150.64	19
5	133.76	1
27	127.03	26
6	107.43	1
21	101.94	19
34	93.11	11
11	91.88	1
17	80.02	4,15
16	70.57	3,15
28	68.19	7,27
26	48.19	6,25
8	44.8	1
18	37.29	16,17
33	36.53	13
35	35.3	32,33,34
7	35.2	1
30	34.5	28,29
36	34.1	35
23	31.52	19
12	27.06	2
3	25.82	1
32	24.12	10,31
25	23.37	20,21,22,23,24
31	16.67	9,30
9	16.04	1
19	15.36	5,18
29	13.93	8,27
14	13.3	2
20	11.55	19
13	11.52	2
4	9.91	1
15	7.12	12,13,14
22	7.06	19
10	5.25	1
1	0	---

All the activities are arranged as per Largest Candidate Rule and assigned too stations which is shown in the below Table 4.6

Table 4.6: Activities assigned to stations as per LCR method

ACTIVIT Y NO	TIME (Min)	PREDECESSOR	STATION	STATION TIME
1	0	---	I	475.2
2	156.9	1		
5	133.76	1		
6	107.43	1		
8	44.8	1		

12	27.06	2	II	454.49
10	5.25	1		
11	91.88	1		
7	35.2	1		
3	25.82	1		
9	16.04	1		
14	13.3	2		
13	11.52	2		
4	9.91	1		
15	7.12	12,13,14		
34	93.11	11		
17	80.02	4,15		
16	70.57	3,15		
18	37.29	16,17		
33	36.53	13		
19	15.36	5,18	III	463.45
20	11.55	19		
24	150.64	19		
21	101.94	19		
23	31.52	19		
25	23.37	20,21,22,23,24		
22	7.06	19		
26	48.19	6,25		
27	127.03	26		
28	68.19	7,27		
29	13.93	8,27	IV	353.84
30	34.5	28,29		
31	16.67	9,30		
32	24.12	10,31		
35	35.3	32,33,34		
36	34.1	35		

Calculations:

Summary of data:

Sum of Talk Time = 1746.98

Governing element = 475.2

$\eta_{th} = (\text{Sum of talk time}) / CT$

$\eta_{th} = 1746.98 / 475.2 = 3.67 \sim 4$

Theoretical number of stations ( $\eta_{th}$ ) = 4

Number of Stations as per LCR Method (m) = 4

$$LE = \frac{\sum_{i=1}^N ST_i}{m \times CT}$$

LE = 1746.98 / (4 \* 475.2)

= 0.9190

= 91.90%

Balance Delay = BD = 1 - LE

BD = 1 - 0.9190

= 0.0809

= 8.09%

Smoothness Index =

$SI = \sqrt{[(0)]^2 + [(475.2 - 454.48)]^2 + [(475.2 - 463.45)]^2 + [(475.2 - 353.84)]^2}$

SI = 123.67

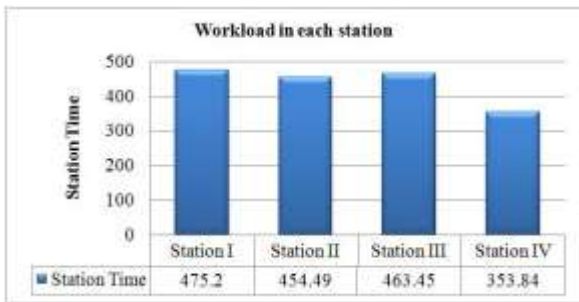

Figure 4.8: Workload distribution as per LCR method

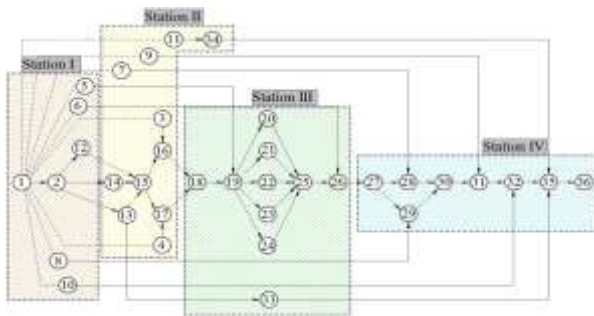

Figure 4.9: Precedence Diagram as per LCR method



Figure 4.10: configuration of stations as per LCR method

16	1	3,15	70.57
3	1	1	25.82
4	1	1	9.91
18	2	16,17	37.29
5	2	1	133.76
19	2	5,18	15.36
24	2	19	150.64
21	2	19	101.94
23	2	19	31.52
20	2	19	11.55
22	2	19	7.06
25	2	20,21,22,23,24	23.37
6	3	1	107.43
26	3	6,25	48.19
27	3	26	127.03
28	3	7,27	68.19
8	3	1	44.8
7	3	1	35.2
29	3	8,27	13.93
30	3	28,29	34.5
31	4	9,30	16.67
9	4	1	16.04
32	4	10,31	24.12
10	4	1	5.25
34	4	11	93.11
11	4	1	91.88
33	4	13	36.53
35	4	32,33,34	35.3
36	4	35	34.1

All the activities are arranged as per Kilbridge and Wester Column Method and assigned to stations which is shown in below Table 4.8

Table 4.8: Activities assigned as per KWC method

ACTIVITY	PREDECESSOR	TIME (Min)	STATION	STATION TIME		
1	---	0	I	470.64		
2	1	156.9				
12	2	27.06				
13	2	11.52				
14	2	13.3				
15	12,13,14	7.12				
3	1	25.82				
4	1	9.91				
5	1	133.76				
8	1	44.8				
7	1	35.2				
10	1	5.25				
17	4,15	80.02				
16	3,15	70.57				
18	16,17	37.29				
19	5,18	15.36				
24	19	150.64				
21	19	101.94				
20	19	11.55				
22	19	7.06				
23	19	31.52				
25	20,21,22,23,24	23.37				
6	1	107.43				
26	6,25	48.19				
27	26	127.03				
28	7,27	68.19				
29	8,27	13.93				
30	28,29	34.5				
31	9,30	16.67				
			II	474.43		
					III	470.83

**Analysis by Kilbridge and Wester Column (KWC) method**

Precedence diagram with all activities divided in to four columns shown in Figure 4.11

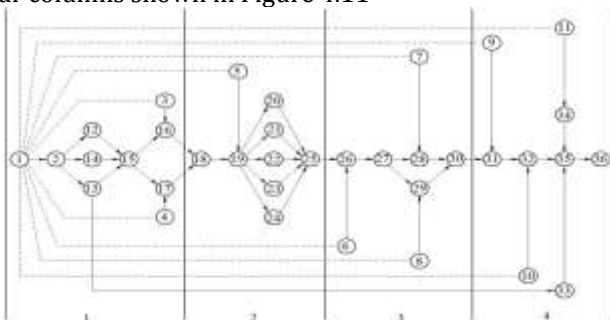

Figure 4.11: Precedence Diagram for KWC method

All the activities arranged in the increasing order of columns and the corresponding data are also tabulated shown in the Table 4.7

Table 4.7: Activities arranged as per KWC method

ACTIVITY	COLUMN	PREDECESSOR	TIME(Min)
1	1	---	0
2	1	1	156.9
12	1	2	27.06
13	1	2	11.52
14	1	2	13.3
15	1	12,13,14	7.12
17	1	4,15	80.02

9	1	16.04	IV	331.08
32	10,31	24.12		
11	1	91.88		
33	13	36.53		
35	32,33,34	35.3		
36	35	34.1		
34	11	93.11		

Calculations:

Summary of data:

Sum of Talk Time = 1746.98

Governing element = 474.43

$\eta_{th} = (\text{Sum of talk time})/CT$

$\eta_{th} = 1746.98/474.43 = 3.68 \sim 4$

Theoretical number of stations ( $\eta_{th}$ ) = 4

Number of Stations as per KWC method (m) = 4

$$LE = \frac{\sum_{i=1}^N ST_i}{m \times CT}$$

Line Efficiency =

$$LE = 1746.98 / (4 \times 474.43) = 0.9207 = 92.07\%$$

Balance delay =  $BD = 1 - LE$

$BD = 1 - 0.9207 = 0.0792 = 7.92\%$

$$SI = \sqrt{\sum_{i=1}^N (ST_{max} - ST_i)^2}$$

Smoothness Index =

$$SI = \sqrt{((474.43 - 470.64))^2 + ((0))^2 + ((474.43 - 470.83))^2 + ((474.43 - 331.08))^2}$$

SI = 143.36

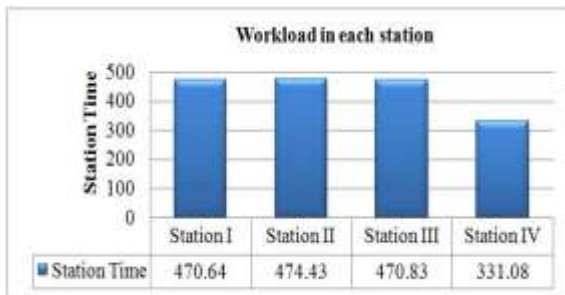

Figure 4.12: Workload distribution of stations as per KWC method

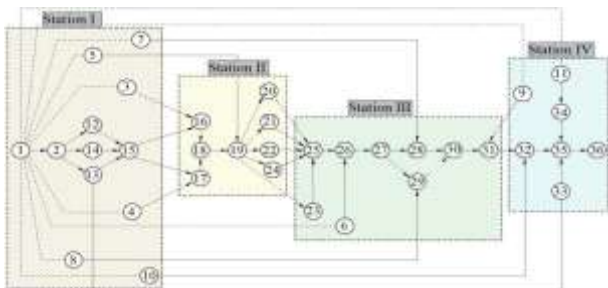

Figure 4.13: Precedence Diagram as per KWC method



Figure 4.14: Configuration of stations as per KWC method

### 4.2 Data collection of DD100 compactor for present assembly line

Activities time and precedence relationships for present assembly line of Duel Drum Compactor of (DD100) is shown in the below Table 4.9

Table 4.9: Precedence Table

ACTIVITY NO	ACTIVITY DESCRIPTION	TIME (Min)	PREDECESSOR
1	Start(DD100)	0	---
2	Main frame sub assembly	53.12	1
3	Hydraulic & Fuel Tank Sub assembly	13.58	1
4	Swivel Frame Sub Assembly	19.2	1
5	Engine Sub Assembly	63.85	1
6	Platform Assembly	71.02	1
7	Cowling and hood sub assembly	29.99	1
8	Sub assembly drum 1	89.94	1
9	Sub assembly drum 2	83.23	1
10	Valve installation	11.36	2
11	Assembly Number Plate	33.6	2
12	Adaptor, shock mount, other sensors installation	44.73	3
13	Hose installation	19.28	10
14	Hydraulic & Fuel Tank installation	50.42	3,12,13
15	Swivel Frame Sub Assembly installation	48.96	4,13
16	Hose Installation	44.12	14,15
17	Engine Installation	33.48	5,16
18	Mud Filter Assembly	15.18	17
19	Radiator installation	46.66	17
20	Cooler installation	36.56	17
21	Recovery Bottle Mounting	17.41	17
22	Installation Exhaust System and air inlet	36.08	17
23	Hydraulic Hose and Engine harness	30.54	18,19,20,21,22
24	Control Box Installation	41.33	6,23
25	Battery Mounting	20.1	24
26	Hose installation	46.51	25
27	Console and seat installation	49.53	26
28	Cowling and hood installation	15.5	7,27
29	Hose installation	37.68	28
30	Sunshade mounting	15.47	11,29
31	Bearing Housing	55.12	8,9
32	Drum assembly	111.5	30,31
33	Shim Insertion	45.51	32
34	Hose installation	46.8	32
35	Oil and coolant fill and battery connection	13.76	33,34

Below Figure 4.15 shows the precedence diagram for Duel drum compactor assembly line of DD100 Compactor. The precedence diagram is drawn as per the precedence relationship among the various activities.



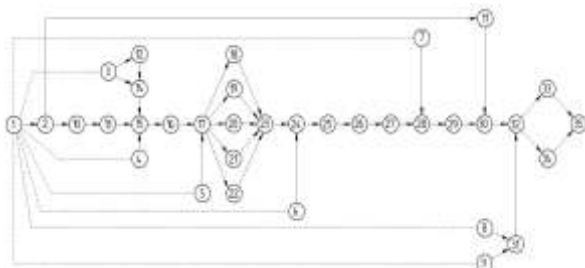

Figure 4.15: Precedence Diagram



Figure 4.16: Workload distribution of stations

Station time at present assembly line

Activities in each station and total station time as per the present assembly line of DD100 Compactor is tabulated in the Table 4.10

Table 4.10: Station time and its activities

Activities	Station	Station Time (Min)
1, 2, 12, 13, 14, 15	I	83.76
3, 4, 16, 17, 18	II	236.19
5, 19, 20, 21, 22, 23, 24, 25	III	228.5
6, 26, 27	IV	215.04
7, 8, 28, 29, 30	V	132.7
9, 10, 31, 32	VI	222.24
11, 33, 34, 35, 36	VII	272.69
<b>Total Station Time</b>		<b>1391.12</b>

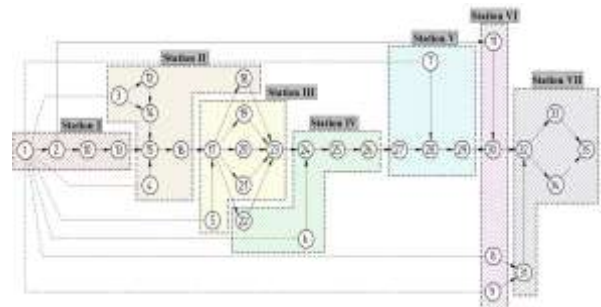

Figure 4.17: Precedence Diagram showing stations



Figure 4.18: Configuration of present assembly line (DD100)

Calculations for Present assembly line of DD100 compactor

Summary of data:

Sum of Talk Time = 1391.12

Governing element = 272.69

$$\eta_{th} = (\text{Sum of talk time}) / CT$$

$$\eta_{th} = 1391.12 / 272.69 = 5.1 \sim 6$$

Theoretical number of stations ( $\eta_{th}$ ) = 6

Actual number of Stations ( $m$ ) = 7

$$LE = \frac{\sum_{i=1}^N ST_i}{m \times CT}$$

$$LE = 1391.12 / (7 \times 272.69)$$

$$= 0.7287$$

$$= 72.87\%$$

Balance Delay =  $BD = 1 - LE$

$$BD = 1 - 0.7287$$

$$= 0.2712$$

$$= 27.12\%$$

Smoothness Index =

$$SI = \sqrt{\sum_{i=1}^N (ST_{max} - ST_i)^2}$$

$$SI = \sqrt{((272.69 - 83.76))^2 + ((272.69 - 236.19))^2 + \dots + ((272.69 - 222.24))^2 + ((0))^2}$$

$$SI = 253.86$$

$$SI = 253.86$$

### Analysis by Ranked Positional Weight (RPW) method

From the collected data Ranked Positional Weight is found and tabulated in the below Table 5.11

Table 4.11: Calculated RPWs for activities

ACTIVITY NO	TIME (Min)	RPW	PREDECESSOR
1	0	1391.12	---
2	53.12	870.04	1
3	13.58	861.41	1
12	44.73	847.83	3
14	50.42	802.1	3,12,13
10	11.36	783.32	2
13	19.28	771.96	10
4	19.2	771.88	1
15	48.96	752.68	4,13
5	63.85	721.45	1
16	44.12	703.72	14,15
17	33.48	659.6	5,16
19	46.66	520.89	17
6	71.02	514.71	1
20	36.56	510.79	17
22	36.08	510.31	17
21	17.41	491.64	17
18	15.18	489.41	17
23	30.54	474.23	18,19,20,21,22
24	41.33	443.69	6,23
25	20.1	402.36	24
26	46.51	382.26	25
8	89.94	362.63	1
9	83.23	355.92	1

27	49.53	335.75	26
7	29.99	316.21	1
28	15.5	286.22	7,27
31	55.12	272.69	8,9
29	37.68	270.72	28
11	33.6	266.64	2
30	15.47	233.04	11,29
32	111.5	217.57	30,31
34	46.8	60.56	32
33	45.51	59.27	32
35	13.76	13.76	33,34

All the activities are Arranged as per RPW method and assigned to stations which is shown in the Table 4.12

Table 4.12: Activities assigned to stations per RPW method

ACTIVITY NO	TIME (Min)	RPW	PREDECESSOR	STATION	STATION TIME
1	0	1391.1	---	I	254.35
2	53.12	870.04	1		
3	13.58	861.41	1		
12	44.73	847.83	3		
10	11.36	783.32	2		
13	19.28	771.96	10		
4	19.2	771.88	1	II	265.43
15	48.96	752.68	4,13		
16	44.12	703.72	14,15		
14	50.42	802.1	3,12,13		
5	63.85	721.45	1		
17	33.48	659.6	5,16		
19	46.66	520.89	17	III	243.71
6	71.02	514.71	1		
20	36.56	510.79	17		
22	36.08	510.31	17		
21	17.41	491.64	17		
18	15.18	489.41	17		
23	30.54	474.23	18,19,20,21,22	IV	268.19
24	41.33	443.69	6,23		
25	20.1	402.36	24		
26	46.51	382.26	25		
8	89.94	362.63	1		
9	83.23	355.92	1		
27	49.53	335.75	26	V	253.37
7	29.99	316.21	1		
28	15.5	286.22	7,27		
31	55.12	272.69	8,9		
29	37.68	270.72	28		
11	33.6	266.64	2		
30	15.47	233.04	11,29	VI	106.07
32	111.5	217.57	30,31		
34	46.8	60.56	32		
33	45.51	59.27	32		
35	13.76	13.76	33,34		

Calculations:

Summary of data:

Sum of Talk Time = 1391.12

Governing element = 268.19

$n_{th} = (\text{Sum of talk time})/CT$

$n_{th} = 1391.12/268.19 = 5.1 \sim 6$

Theoretical number of stations ( $n_{th}$ ) = 6

Number of Stations as per RPW Method (m) = 7

$$LE = \frac{\sum_{i=1}^N ST_i}{m \times CT}$$

Line Efficiency =  $LE = \frac{\sum_{i=1}^N ST_i}{m \times CT}$   
 $LE = 1391.12 / (6 \times 268.19)$   
 $= 0.8645$   
 $= 86.45\%$

Balance Delay =  $BD = 1 - LE$   
 $BD = 1 - 0.8645$   
 $= 0.1354$   
 $= 13.54\%$

$$SI = \sqrt{\frac{\sum_{i=1}^m (ST_{max} - ST_i)^2}{m}}$$

Smoothness Index =  $SI = \sqrt{[(268.19 - 254.35)]^2 + [(268.19 - 265.43)]^2 + \dots + [(0)]^2 + [(268.19 - 106.07)]^2}$   
 $SI = 31.90$

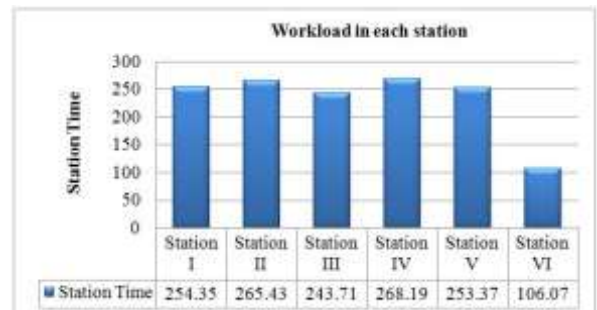

Figure 4.19: Workload distribution as per RPW method

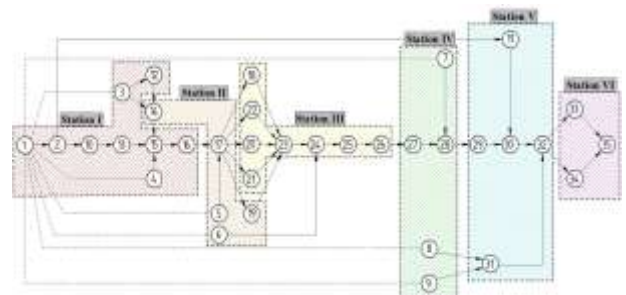

Figure 4.20: Precedence Diagram as per RPW method



Figure 4.21: Configuration of stations as per RPW method

**Analysis by Largest Candidate Rule (LCR) method**

All the activities are arranged as per the Largest Candidate Rule which is shown in the below Table 4.13

Table 4.13: Activities arranged as per LCR method

ACTIVITY NO	TIME (Min)	PREDECESSOR
1	0	---
32	111.5	30,31
8	89.94	1
9	83.23	1
6	71.02	1

5	63.85	1
31	55.12	8,9
2	53.12	1
14	50.42	3,12,13
27	49.53	26
15	48.96	4,13
34	46.8	32
19	46.66	17
26	46.51	25
33	45.51	32
12	44.73	3
16	44.12	14,15
24	41.33	6,23
29	37.68	28
20	36.56	17
22	36.08	17
11	33.6	2
17	33.48	5,16
23	30.54	18,19,20,21,22
7	29.99	1
25	20.1	24
13	19.28	10
4	19.2	1
21	17.41	17
28	15.5	7,27
30	15.47	11,29
18	15.18	17
35	13.76	33,34
3	13.58	1
10	11.36	2

28	15.5	7,27		
29	37.68	28		
30	15.47	11,29		
32	111.5	30,31		
33	45.51	32	VI	217.57
34	46.8	32		
35	13.76	33,34		

Calculations:

Summary of data:

Sum of Talk Time = 1391.12

Governing element = 263.39

$\eta_{th} = (\text{Sum of talk time})/CT$

$\eta_{th} = 1391.12/263.39 = 5.28 \sim 6$

Theoretical number of stations ( $\eta_{th}$ ) = 6

Number of Stations as per LCR Method (m) = 7

$$LE = \frac{\sum_{i=1}^N ST_i}{m \times CT}$$

Line Efficiency =

$$LE = 1391.12 / (6 \times 263.39)$$

$$= 0.8802$$

$$= 88.02\%$$

Balance Delay =  $BD = 1 - LE$

$$BD = 1 - 0.8802$$

$$= 0.1197$$

$$= 11.97\%$$

All the activities are arranged as per Largest Candidate Rule and assigned too stations which is shown in the below Table 4.14

Table 4.14: Activities arranged as per LCR method

ACTIVITY NO	TIME (Min)	PREDECESSOR	STATION	STATION TIME
1	0	---	I	263.39
8	89.94	1		
9	83.23	1		
6	71.02	1		
4	19.2	1		
5	63.85	1	II	260.62
31	55.12	8,9		
2	53.12	1		
11	33.6	2		
7	29.99	1		
3	13.58	1	III	258.4
10	11.36	2		
12	44.73	3		
13	19.28	10		
14	50.42	3,12,13		
15	48.96	4,13	IV	226.45
16	44.12	14,15		
17	33.48	5,16		
21	17.41	17		
19	46.66	17		
20	36.56	17	V	164.69
22	36.08	17		
18	15.18	17		
23	30.54	18,19,20,21,22		
24	41.33	6,23		
25	20.1	24		
26	46.51	25		
27	49.53	26		

$$SI = \sqrt{\sum_{i=1}^n (ST_{max} - ST_i)^2}$$

Smoothness Index =

$$SI = \sqrt{[(0)]^2 + [(263.39 - 260.62)]^2 + [(263.39 - 258.4)]^2 + \dots + [(263.39 - 217.57)]^2}$$

SI=115.05

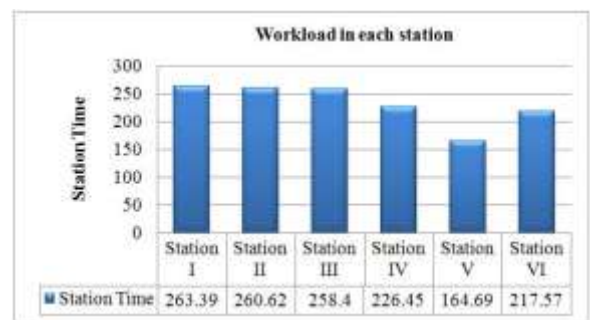

Figure 4.21: Workload distribution as per LCR method

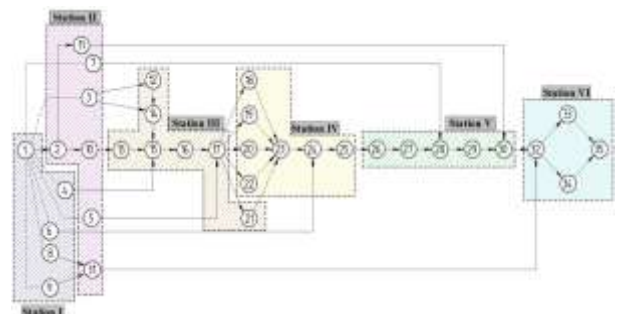

Figure 4.21: Precedence Diagram as per LCR method



Figure 4.22: Configuration of stations as per LCR method

**Analysis by Kilbridge and Wester Column (KWC) method**

Precedence diagram with all activities divided in to SIX columns is shown in Figure 5.43

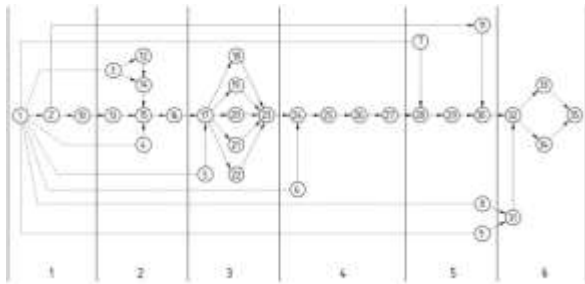

Figure 4.23: Precedence Diagram for KWC method

All the activities arranged in the increasing order of columns and the corresponding data are also tabulated shown in the Table 4.15

Table 4.15: Activities arranged as per KWC method

ACTIVITY	COLUMN	PREDECESSOR	TIME(Min)
1	1	---	0
2	1	1	53.12
10	1	2	11.36
13	2	10	19.28
3	2	1	13.58
12	2	3	44.73
14	2	3,12,13	50.42
15	2	4,13	48.96
4	2	1	19.2
16	2	14,15	44.12
17	3	5,16	33.48
5	3	1	63.85
18	3	17	15.18
19	3	17	46.66
20	3	17	36.56
21	3	17	17.41
22	3	17	36.08
23	3	18,19,20,21,22	30.54
24	4	6,23	41.33
6	4	1	71.02
25	4	24	20.1
26	4	25	46.51
27	4	26	49.53
7	5	1	29.99
28	5	7,27	15.5
29	5	28	37.68
11	5	2	33.6
30	5	11,29	15.47
8	5	1	89.94
9	5	1	83.23
32	6	30,31	111.5
31	6	8,9	55.12
33	6	32	45.51
34	6	32	46.8
35	6	33,34	13.76

All the activities are arranged as per Kilbridge and Wester Column Method and assigned to stations which is shown in below Table 4.16

Table 4.16: Activity assigned to station as per KWC method

ACTIVITY	PREDECESSOR	TIME(Min)	STATION	STATION TIME
1	---	0	I	260.65
2	1	53.12		
10	2	11.36		
13	10	19.28		
3	1	13.58		
12	3	44.73		
14	3,12,13	50.42	II	257.26
4	1	19.2		
15	4,13	48.96		
16	14,15	44.12		
5	1	63.85		
17	5,16	33.48		
18	17	15.18	III	245.58
19	17	46.66		
20	17	36.56		
21	17	17.41		
22	17	36.08		
23	18,19,20,21,22	30.54		
24	6,23	41.33	IV	271.71
6	1	71.02		
25	24	20.1		
26	25	46.51		
27	26	49.53		
7	1	29.99		
28	7,27	15.5	V	249.85
29	28	37.68		
11	2	33.6		
30	11,29	15.47		
8	1	89.94		
9	1	83.23		
31	8,9	55.12	VI	106.07
32	30,31	111.5		
33	32	45.51		
34	32	46.8		
35	33,34	13.76		

Calculations:

Summary of data:

Sum of Talk Time = 1391.12

Governing element = 271.71

$$\eta_{th} = (\text{Sum of Talk Time}) / CT$$

$$\eta_{th} = 1391.12 / 271.71 = 5.11 \sim 6$$

Theoretical number of stations ( $\eta_{th}$ ) = 6

Number of Stations as per KWC method (m) = 6

$$LE = \frac{\sum_{i=1}^N ST_i}{m \times CT}$$

$$LE = 1391.12 / (6 \times 271.71)$$

$$= 0.8533 = 85.33\%$$

Balance Delay = BD = 1 - LE

$$BD = 1 - 0.8533 = 0.1466 = 14.66\%$$

$$SI = \sqrt{\frac{\sum_{i=1}^n (ST_{max} - ST_i)^2}{n}}$$

Smoothness Index =

$$SI = \sqrt{((271.71 - 260.65)^2 + \dots + ((0)^2 + ((271.71 - 249.85)^2 + ((271.71 - 106.07)^2))}$$

SI=170.08

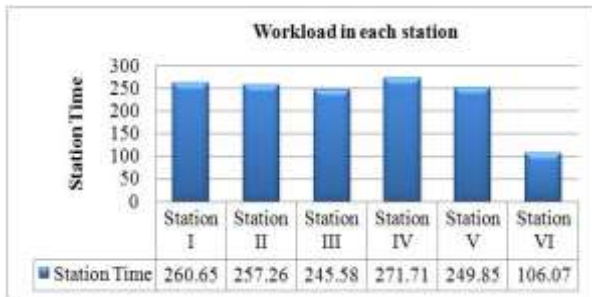

Figure 5.44: Workload distribution as per KWC method

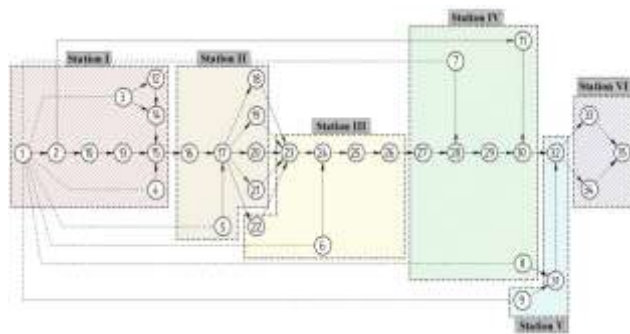

Figure 5.45: Precedence Diagram as per KWC method



Figure 5.46: Configuration of stations as per KWC method

## 5. RESULTS AND CONCLUSIONS

### 5.1 Results:

Data's are collected and calculations are done for the present assembly line of road machinery with the application of Ranked Positional Weight Method, Largest Candidate Rule Method, Kilbridge and Wester Column method. Results of those calculations of single drum and duel drum compactor assembly line is shown in the below Table 5.1

Table 5.1: Table of Results

Compactor	method	Line Efficiency	Balance Delay	Smoothness Index	No of station
SD110	Present	0.5251	0.4748	318.11	7
	RPW	0.9279	0.0720	128.26	4
	LCR	0.9190	0.0809	123.67	4
	KWC	0.9207	0.0792	143.36	4
DD100	Present	0.7287	0.2713	253.86	7
	RPW	0.8645	0.1354	31.90	6
	LCR	0.8802	0.1197	115.058	6
	KWC	0.8533	0.1466	170.08	6

The line efficiency and balance delay of single drum compactor (SD110) assembly line for present method is 0.5262 and 0.4738 respectively. After applying assembly line balancing techniques such as Ranked Positional Weight Technique, Largest Candidate Rule Technique and Kilbride and Wester Column Technique to present assembly line, the assembly line efficiency can be improved. As per Ranked Positional Weight the line efficiency can be improved up to 0.9279 and thereby reducing the balance delay up to 0.0720 and as per largest candidate rule techniques the line efficiency can be improved up to 0.9190 and thereby reducing the balance delay up to 0.0809 and as per Kilbride and wester column Technique the line efficiency can be improve up to 0.9207 thereby reducing balance delay up to 0.0792. If we consider the smoothness index the LCR method has an edge over the other methods, this will be helpful if the company wants a smooth operation without any bottleneck or delay.

The line efficiency and balance delay of Duel drum compactor (DD100) assembly line for present method is 0.7287 and 0.2713 respectively. After applying assembly line balancing techniques such as Ranked Positional Weight Technique, Largest Candidate Rule Technique and Kilbride and Wester Column Technique to present assembly line, the assembly line efficiency can be improved. As per Ranked Positional Weight the line efficiency can be improved up to 0.8645 and thereby reducing the balance delay up to 0.1354 and as per largest candidate rule techniques the line efficiency can be improved up to 0.8802 and thereby reducing the balance delay up to 0.1197 and as per Kilbride and wester column Technique the line efficiency can be improve up to 0.8533 thereby reducing balance delay up to 0.1466. If we consider the smoothness index in the RPW method has an edge over the other methods, this will be helpful if the company wants smooth operations without any bottleneck or delay.

### 5.2 Conclusions:

After comparing results after applying all three methods it is found that any one of the both RPW Method or LCR Method applicable for the line balancing as both of these methods are able to assign the activities to the number of workstations in more efficient manner than kilbride and wester column technique. In all the methods the number of work stations is reduced and the efficiency of the line has increased which intern increases the productivity of the line. The conclusion obtained from the results are shown below, the key outcome is reduction in balance delay, Smoothness index and increased line efficiency.

For SD110 Compactor the use of RPW Method gives the best line balance, new assembly line with reduction of work stations to 4 stations with balance delay of 7.2 %, Line Efficiency of 92.79% and Smoothness Index of 128.26.

For DD100 Compactor the use of LCR Method gives the best line balance, new assembly line with reduction of work stations to 6 stations with balance delay of 11.97 %, Line Efficiency of 88.02% and Smoothness Index of 115.058.

For SD110 Compactor initial production trajectory has 7 workstations, after balancing the number of stations obtained 4 stations.

For DD100 Compactor initial production trajectory has 7 workstations, after balancing the number of stations obtained 6 stations.

## REFERENCES

- [1] Adarsh Adeppa, "A Study on Basics of Assembly Line Balancing", International Journal on Emerging Technologies (special issue on NCRIET-2015)6(2):294-297, 2015.
- [2] Vrittika V Pachghare and R S Dalu, "Assembly Line Balancing Methods - A Case Study", International Journal of Science and Research (IJSR) ISSN (Online): 2319-1064 Impact Factor: 3.358, 2012.
- [3] Gourav Kumar and Dr. Praveena Gowda, "An optimal balancing of assembly line using RPW Technique", International Journal of Engineering Research and Advanced Technology (IJERAT) ISSN: 2454-6135[Special Volume.02 Issue.01], 2016.
- [4] Anoop Kumar and Nagaraj, "Minimizing number of stations and cycle time for Mixed Model Assembly Line", International Journal of Engineering Research & Technology (IJERT), Vol.3 Issue 8, ISSN: 2278-0181, 2014.
- [5] Armin Scholl and Stefan Vob, "Simple assembly line balancing - Heuristic approaches", Journal of Heuristics: 2, 217-214, 1996.
- [6] P. Srivasankaran and P. Shahabudeen, "Literature review of assembly line balancing problems, The International Journal of Advance Technology: 73:1665-1694, 2014.
- [7] Naven Kumar and Dalgobind Mahto, "Assembly Line Balancing: A Review of Developments and trend in approach to Industrial Application", Global Journal of Researches a Engineering Industrial Engineering; Volume 13, Issue 2, Version 1.0,2013.
- [8] Becker C and Scholl A, "A survey on problems and methods in generalized assembly line Balancing", European Journal of Operational Research, Volume 168, Issue3, pp-694-715,2006.
- [9] Amen, M, "Heuristic Methods for Cost-Oriented Assembly Line Balancing: A survey", International Journal of Production Economics, 68 (1), 1-14, 2000.
- [10] Kriengkarakot, N, & Pianthong, N, "The assembly line balancing problem". KKU Engineering Journal, 34(2), 133-140, 2007.
- [11] Boysen, N. Fliedner & Scholl, "A classification of assembly line balancing problems", European Journal of Operational Research 183, pp. 674-693, 2007.
- [12] Chutima. P & Chimklai. P, "Multi-objective two-sided mixed-model assembly line balancing using particle swarm optimization with negative knowledge", Computers & Industrial Engineering, 62(1), pp. 39-55, 2012.
- [13] Pearce. B, "A study on general assembly line balancing modeling methods and techniques", Journal of industrial engineering, 1549, 2015.
- [14] Yeoh Kim Hao, "Efficiency Improvement of Assembly Line", Case study of bus manufacturer, 6-40, 2013.
- [15] Sandeep Choudhary, Sunil Agrawal, "Mixed-Model Assembly Line Balancing Problem: A Focus on Model Formulation", All India Manufacturing Technology, Design and Research Conference, 2014.