

## CFD ANALYSIS OF SPARE WHEEL RUNNER FOR USING EASY CAR PARKING

<sup>1</sup>R.Satheesh kumar, <sup>2</sup>M.Balamurugan, <sup>3</sup> K.Chandrakasan, <sup>4</sup>S.Gunasheelan, <sup>5</sup>K.Hithayathulla

<sup>1</sup>Assistant Professor, Department of Mechanical Engineering, Dhanalakshmi Srinivasan Institute of Technology, Tamil Nadu, India.

<sup>2,3,4,5</sup> UG Students, Department of Mechanical Engineering, Dhanalakshmi Srinivasan Institute of Technology, Tamil Nadu, India.

\*\*\*

**Abstract** - Car parking in rush area is one of the biggest problem in car parking circumferences. Nowadays the increase in the production and purchase of car as mandatory for a family, locating them in parking area is very big problem. Due to non-availability of space car parking becomes a bit difficult task. Hence we planned to design a new model of spare wheel which is located in the backside of the car, which rotates at 360 degree for transformation of vehicle load from single location. Here the design is been carried out for the design of chassis with the model of the fifth tyre and its location is been designed. The modeling is carried out in pro e and structural validations have been done in CFD.

**Key words:** Iron steel, hard rubber, alloy steel, centralized cylinder, pro-e modelling, ansys and simulation

### 1. INTRODUCTION

In 1950s, The Walker had developed a parallel wheel parking system for automobiles and trucks and he developed in his conception in an exceedingly Saab sedan car conjointly developed his self -parking conception in ford beach waggon. conjointly in 1970s of these ideas of automobiles modifying by that tire may be fitted underneath chassis and hidden underneath the car, motivated once the method begin for parking in slots. every of this method got to set at very cheap of every automobile. This mechanism was fitted underneath the chassis that with facilitate of rack and pinion or with the assistance of centrally fitted worm and gear wheel. The Packard Cavalier developed the conception that is totally different from Walkers parking conception. The Packard used the additional tire for the parking and this originated was used move the automobile in circular arrangement. this idea applied to the automobile with none changes within the entities or in structure of automobile. Mr.Paresh,et,al[2018] introduce a steering mechanism which offers feasible solutions to a number of current maneuvering limitations. A prototype for the proposed approach was developed by introducing separate mechanism for normal steering purpose and 360 degree steering purpose. This prototype was found to be able to be maneuvered very easily in tight spaces, also making 360\_ steering possible. [1]

Tiberiu Giurgiu et,al The paper deals with modeling and simulation of the static and dynamic behavior of radial tires for civil emergency vehicles or military armored vehicles. The results indicates The tires on military armored vehicles have a more complex configuration than the civil ones. The complexity is required by the specific missions of this type of vehicles and the intense stress subjected by the tire during the movement on different types of terrain. [2] Amol banker, et,al[2015] In this paper, finite element (FE) model for analysis of tyre rolling on the drum is presented. Tyre cornering simulation using an implicit finite element analysis is carried out for 215/60R17 tyre are cornering force is compared with experimental results from force & moment (F&M) (In-door test method.). the results show At higher slip angles, a large percentage of tread surface is slipping and thus the tyre footprint plays an important role in generation of tyre forces. Contact area decreases with increasing slip angle. Analysis carried out up to 3 degree slip angle with constant load and inflation pressure. [3] Sadda. Mahendra, et,al, [2014] the effect of tyre over load and inflation pressure on the rolling loss and fuel consumption is analyzed. The investigations are made on two models of tyre Skoda Rapid and Ford Classic. The analysis is done by applying the loads of car weight and persons weight. When the car is overloaded, also analysis is done. Analysis is done by applying inflation pressure. [4] D.Madhusudhana, et,al [2014] Investigate The Effect Of Tyre Overload And Inflation Pressure On Rolling Loss & Fuel Consumption Of Automobiles Cars. [5] Xiaoguang Yang Presented The Finite Element Analysis And Experimental Investigation Of Tyre Characteristics For Developing Strain-Based Intelligent Tyre System. The study herein thus proposed an effective and efficient method using finite element tyre model, complemented by experiment, to give an insight into the relationship between tyre strain feature and tyre forces. It is expected that these relationships could be used to estimate tyre behaviour and working parameters and then serve for optimizing vehicle dynamics control system and providing tyre warning information for the driver. [6] Grzegorz Motrycz, et,al [2012] The paper describes results of research on heavy vehicle tyre with Run Flat VFI insert. The experiment has included the determination of heat generation, rolling resistance, and radial stiffness of two different tyre designs (textile and steel carcass). The results have been used for the purpose of evaluation of tyre operating characteristics. The study included research on

non-inflated tyre properties. [7] R. Van der Steen [2007] investigated the Tyre/road friction modeling. The results shows to model a tyre and interaction with the environment using the finite element method not only knowledge of materials, geometry and interaction is required, but also a thorough knowledge of the computational mechanics behind the finite element method is required. However the most important conclusion is that the often used Coulomb friction model with a constant coefficient of friction is in general not realistic in the case of rubber friction. [8]

## 2. METHODOLOGY

### 2.1 STATEMENT OF PROBLEM

Car parking in rush area is one of the biggest problem in car parking circumferences. So we are solving the parking problem for using 5<sup>th</sup> wheel for using centralized cylinder at rotate in 360 degree of angle in any direction running condition It will be implementing for working of fifth wheel. a concept of parking is developed for taking least time for parking and aim of this system is to fold the auxiliary wheel for better space adaptability also placed in boot space. This parking can be done using an additional wheel most probably this will be a Stepney wheel.

### 2.2 SELECTION OF MATERIAL

Steel is an alloy of iron and other elements, primarily carbon, widely used in construction and other applications because of its high tensile strength and low cost. The carbon in typical steel alloys may contribute up to 2.1% of its weight. Steel's strength compared to pure iron is only possible at the expense of ductility, of which iron has an excess.

### 2.3 HARD RUBBER

Rubber is the main raw material used in manufacturing tyre and both natural and synthetic rubbers are used. natural rubber is found as a milky liquid in the bark of the rubber tree have a brasiliens is to produce the raw rubber used in tyre manufacturing, the liquid lattes is mixed with acids that cause the rubber solidify.

### 2.4 SPRING

The alloy spring steels have a definite place in the field of spring materials, particularly for conditions involving high stress and for applications where shock or impact loading occurs. Alloy spring steels also can withstand higher and lower temperatures than the high-carbon steels and are obtainable in either the annealed or pre tempered conditions.

## 2.3 PROPERTIES OF MATERIALS

**Table No - 1** Properties of iron steel.

Iron	Density	Yield stress	Poisson's ratio	Youngs modulus
	<b>7.850 gm/cm<sup>3</sup></b>	<b>485 MPa</b>	<b>0.266</b>	<b>200000 MPa</b>

**Table No- 2** Properties of hard rubber

Property	A(N990)
<b>Tensile strength(MPa)</b>	21.0
<b>Elongation (%)</b>	637
<b>Modulus @ 100%(MPa)</b>	1.9
<b>Hardness(Sha)</b>	62
<b>Tear strength(KN/m)</b>	39.2
<b>Compression set (%)</b>	20.7
<b>Tensile strength change after heat aged for 70hr. at 100°C (%)</b>	6.2
<b>Elongation change after heat aged for 70hr.at 100°C (%)</b>	-5.3
<b>E*(MPa)</b>	9.6818
<b>E'(MPa)</b>	9.6280
<b>E''(MPa)</b>	1.0190
<b>Tan</b>	0.1058
<b>Stiffness(KN/mm)</b>	9.0755
<b>Loss energy</b>	4.3567

Table No - 3 Properties of spring

Material	Chrome ASTM A 401
Nominal Analysis	C -51 -59%
	Cr -60 - 80%
	Si1 -20 -1.60%
Minimum Tensile Strength	235-300
Modulus of Elasticity E psi x 10 <sup>3</sup>	30
Design Stress %	45
Minimum Tensile Modulus in Torsion G psi x 10 <sup>6</sup>	11.5
Maximum Temp. °F	475
Maximum Temp. °C	246
Rockwell Hardness	C48-55
Method of Manufacture	Cold drawn and heat treated before
Chief Uses	
Special Properties	Fabrication. Used for shock loads and moderately elevated temperature.

Fig 1 shows Model geometry from the pro-e have been imported in the form of iges. And the material properties of the element have been specified. Also the detail of the bounding material & contact detail have seen specified. Fig 2 represents mesh model of spare wheel.

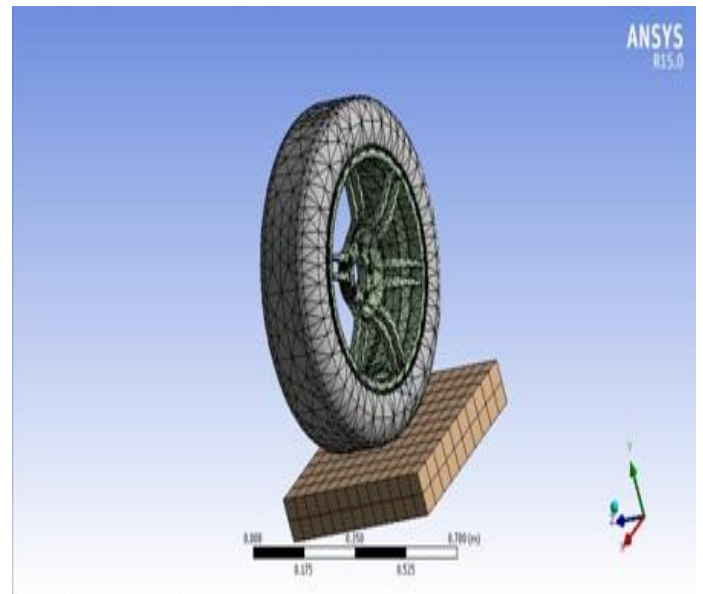

Fig - 2: Mesh model of spare wheel.

Table No -4 Meshing Configuration.

Object Name	Mesh
State	Solved
<b>Defaults</b>	
Physics Preference	Mechanical
Solver Preference	Mechanical APDL
Relevance	0
<b>Sizing</b>	
Use Advanced Size	Off
Function	

### 3. SIMULATION

Generally, as we are draw the chassis diagram for using pro-e software and importing the mesh diagram for using ansys software. The meshed model name automatic and the simulation contain for number of nodes is 48467 and number of element is 24825 and were generated in ansys preprocessing system.

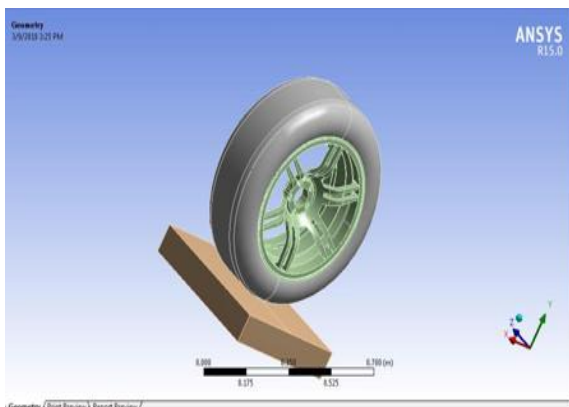

Fig -1: Modeling diagram for spare wheel

Relevance Center	Coarse
Element Size	Default
Initial Size Seed	Active Assembly
Smoothing	Medium
Transition	Fast
Span Angle Center	Coarse
Minimum Edge Length	8.6588e-005 m
Inflation	
Use Automatic Inflation	None
Inflation Option	Smooth Transition
Transition Ratio	0.272
Maximum Layers	5
Growth Rate	1.2
Inflation Algorithm	Pre
View Advanced Options	No
Triangle Surface Mesher	Program Controlled
Topology Checking	Yes
Advanced	
Number of CPUs for	Program Controlled
Parallel Part	
Meshing	
Shape Checking	Standard Mechanical
Element Midside Nodes	Program Controlled
Straight Sided Elements	No
Number of Retries	Default (4)
Extra Retries For	Yes
Assembly	
	Dimensionally
Rigid Body Behavior	Reduced
Mesh Morphing	Disabled
Disfeaturing	
Pinch Tolerance	Please Define
Generate Pinch on	No
Refresh	
Automatic Mesh Based	On
Disfeaturing	

Here the meshed component, where the loading & constrain have been applied. Where the bases of the road have been constrained for zero degree removal, hence the

Defeaturing Tolerance	Default
Statistics	
Nodes	48467
Elements	24825
Mesh Metric	None

bases have been fixed. Loading of tyre have been done, throughout the surface of the tyre.

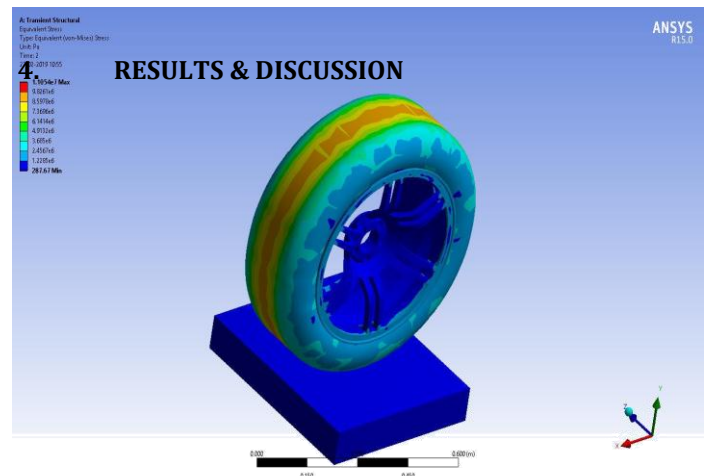

Fig - 3: Total deformation Analysis of spare wheel (17500N).

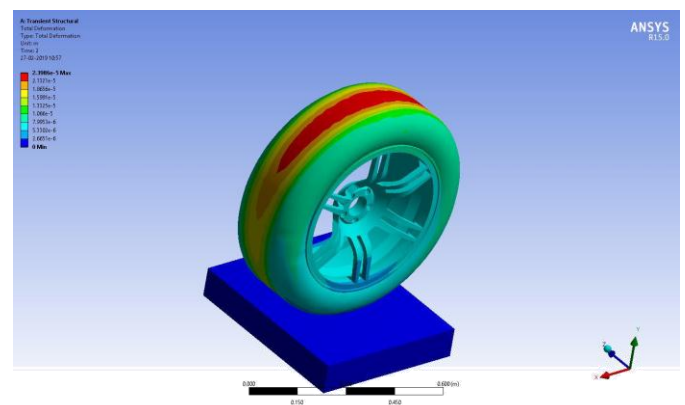

Fig - 4: Equivalent stress Analysis of spare wheel (17500N).

Fig 3 & 4 indicates the total deformation and equivalent stress of spare wheel when maximum load applied (17500N). Maximum 2.3986e-005 m deformation & 1.1054e+007 Pa equivalent stresses are obtained. When

applied minimum load 12500 N the minimum 2.0054e-005 m deformation and 9.212e+006 Pa equivalent stress obtained.

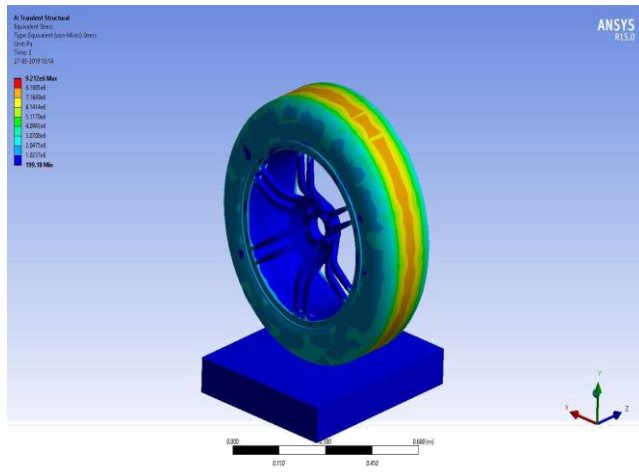

Fig – 5: Total deformation Analysis of spare wheel (12500N).

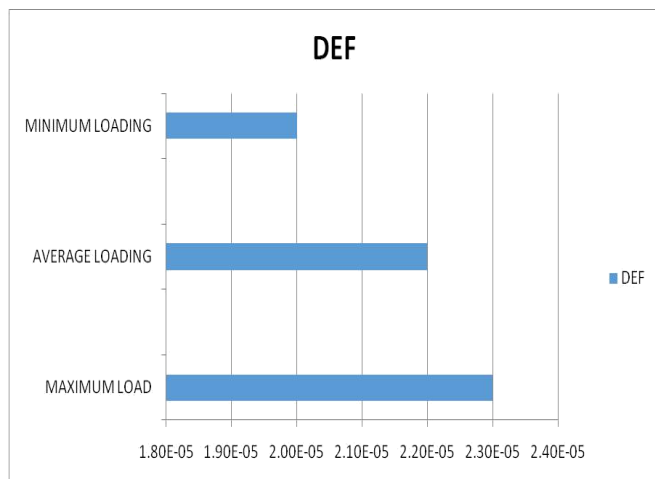

Fig – 6: Equivalent stress Analysis of spare wheel (12500N).

Chart – 1: Variation of Deformation in spare wheel.

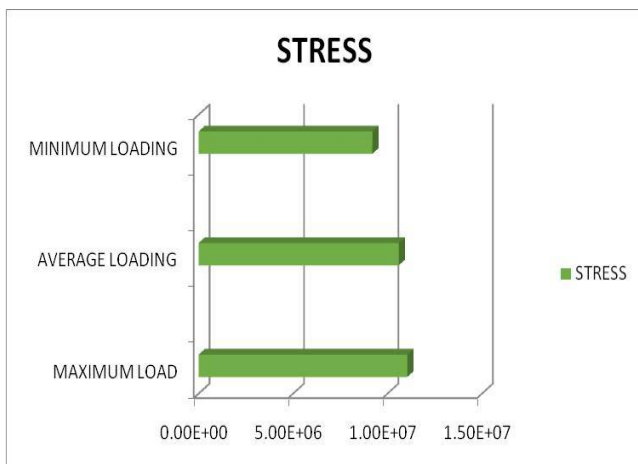
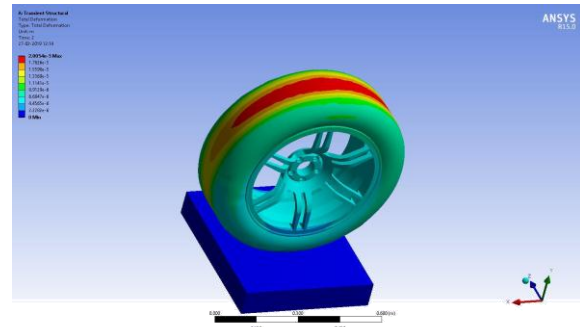

Chart -2: Variation of Stresses in spare wheel.



## 5. CONCLUSION

This is carried out by us made an impressive task in four wheelers. It is very useful for parking four wheelers, because they need not take any risk for park the vehicle and quick operation. This project will reduce the cost involved in the concern. The spare wheel has been designed to analysis using CFD software. Aim for development of a system to useful in the automotive sector. It will be implementing for working of fifth wheel, our aim is to fold the fifth wheel axel for better space adaptability. Hence whenever needed operated must have unfold the fifth wheel axel by actuating rack and pinion. Arrange conventional steering system at front side.

## REFERENCES

- [1] Mr.Paresh,et, al., auxillary drive wheel vehicle parking mechanism(fifth wheel car parking mechanism), ISSN:1314-3395 volume 118, Issue-24, MAY-28 2018.
- [2] Tiberiu riurgiu, et,al., Static and Transient Analysis of Radial Tires Using ANSYS, ISBN:978-1-61804-186-9
- [3] Amol banker,et,al., tyre cornering analysis using finite element analysis and comparison with experiment, ISBN:978-93-82702-84-9, 29th MAR-2015.
- [4] Sadda. Mahendra,et,al., Effect of Tyre Overload and Inflation Pressure on Rolling Loss (resistance) and Fuel Consumption of Automobile Cars, ISSN (e): 2250 – 3005, Vol-04, Issue, 10, October– 2014
- [5] D.Madhusudhana,et,al., effect of tyre overload and inflation Pressure on rolling loss & fuel consumption Of automobiles cars, ISSN: 2349-2163, Volume-1, Issue-8, Sep-2014
- [6] xiaoguang yang, finite element analysis and experimental Investigation of tyre characteristics for developing Strain-based intelligent tyre system, sep-2011.
- [7] Grzegorz Motrycz, et,al., research on operational characteristics of tyres With run flat insert, volume-19, 2012.



[8] R. Van der steen,et.al., tyre/road friction modeling,  
May, 2007.