

A Review on Structural Diagrid System for High Rise Buildings with Buckling Restrained Braced Frame.

Kashif Ansari¹

¹Dept of Design & Engineering, JSW Severfield Structures Ltd (JSSL) Mumbai.

Abstract –High rise building development has been rapidly increasing worldwide, introducing new challenges for the Engineers. Due to increase in population, economic prosperity and also due to the scarcity of lands high-rise structures are preferred This paper presents a review on the literature of diagrid structures and Buckling Restrained Braced Frame. The objective of this paper is to combined the structural diagrid system with Buckling Restrained Braces in high rise buildings subjected to lateral loads.

Key Words: High rise buildings, Diagrid System, Buckling restrained Braced Frame (BRBF), Ductility, Lateral Loads, Storey Displacement, Time period, etc.

1.INTRODUCTION

Structural design of high rise buildings is governed by lateral loads due to wind or earthquake. Lateral load resistance of structure is provided by interior structural system or exterior structural system. While framed tube, braced tube structural system resist lateral loads by elements provided on periphery of structure. It is very important that the selected structural system is such that the structural elements are utilized effectively while satisfying design requirements.

In the construction industry many new ideas have emerged for the construction of high rise buildings, among which one is a diagrid system. Also the Diagrid system is appreciated from the architectural point of view. The system without vertical column led to the birth of diagrid system.

1.1 Structural Diagrid System

Diagrid structures are exterior structures which consist of diagonal struts and ties in the periphery. These diagrids members carry both gravity loads and lateral loads by the axial action of member, but conventional exterior braces carry only vertical loads. One of main advantage of this system is the drastic reduction in the connections in outer periphery compare to normal conventional building. By using this system, the high rise structures can be built to any shape likes square, rectangle and curved structures etc.



Fig -1.1. a: Fairscape Precinct (Botswana)



Fig -1.1. b: Altair (Sri-lanka)

The diagrid system offers several advantages in addition to eliminating perimeter columns. Most notably it optimizes each structural element. Typically, columns are used to provide vertical-load-carrying capacity, and diagonals or braces provide stability and resistance to large forces, such as wind and seismic loads. Diagrids and braces participate in the lateral load transfer, and the columns participates in the gravity loads only.

1.2 Conventional Vs Diagrid System

Diagrid are made up by diagonal elements they are triangular structures with supporting beams (link beams), this system would provide more flexibility to interior planning and exterior appearance is also improved. One of the draw back of the diagrid system is that it has lack of ductility, Conventional moment frame structure is more ductile as compare to the diagrid system.

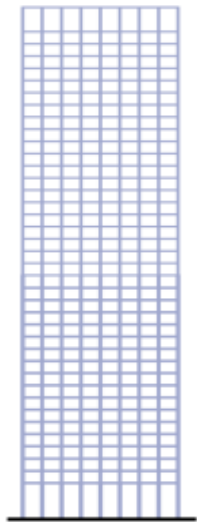

Fig -1.2. a:
Conventional System



Fig -1.2. b:
Diagrid System

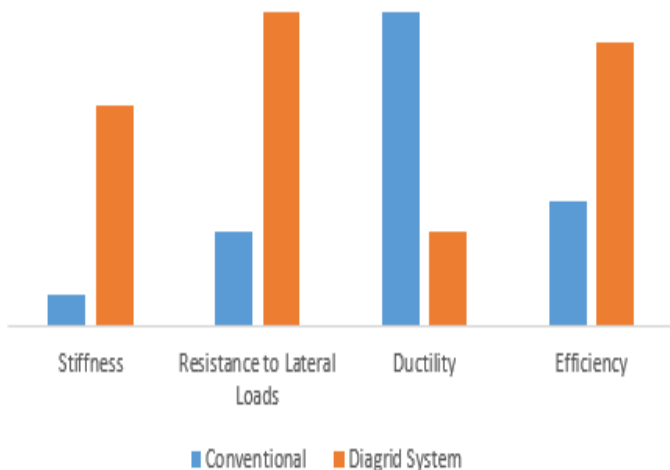

Chart -1.2. a: Conventional Vs Diagrid system

1.3 Buckling Restrained Braced Frame(BRBF)

Buckling-restrained Braced Frames (BRBF) are a new and effective Lateral Load resisting system for engineers in designing the high rise buildings for ductile seismic performance. BRBF provides for a system that can translate the inherent ductility of mild steel into system ductility, thereby controlling the response of the structure to a severe earthquake and presenting an attractive alternative to conventional braced frames.



Fig -1.3. a: Typical BRB

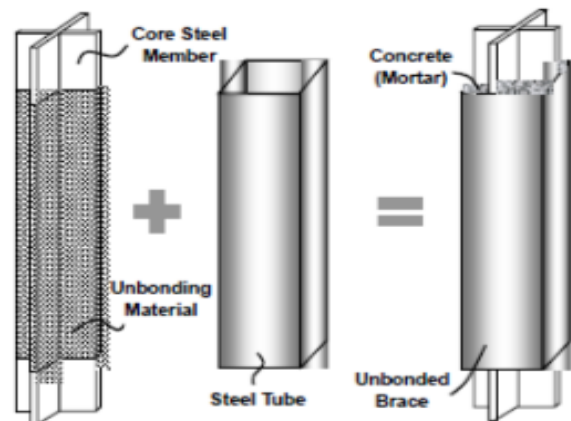

Fig -1.3. b: Schematic of BRB

This system includes the casing surrounding the steel core and structural elements adjoining its connections. The buckling-restraining system is intended to permit the transverse expansion and longitudinal contraction of the steel core for deformations corresponding to 2.0 times the design story drift.

Buckling-restrained braces have full, balanced hysteretic behavior, with compression yielding similar to tension-yielding behavior. They achieve this through the decoupling of the stress-resisting and flexural-buckling resisting aspects of compression strength. And shaped steel core resists axial stresses.

2. LITERATURE REVIEW

Review 2.1

Harish varsani (2015), "Comparative Analysis of Diagrid Structural System and Conventional Structural System for High Rise Steel Building". In this paper, analysis of diagrid structural system and conventional structural systems are presented. Modeling and analysis of structure is done by ETABS software.

From this study it is observed that the drastic reduction in displacements due to lateral loads in the diagrid structure as compare to the conventional building. Nearly 70-75% reduction in the storey displacements was observed. And the massive reduction in natural time period also observed in the diagrid structure.

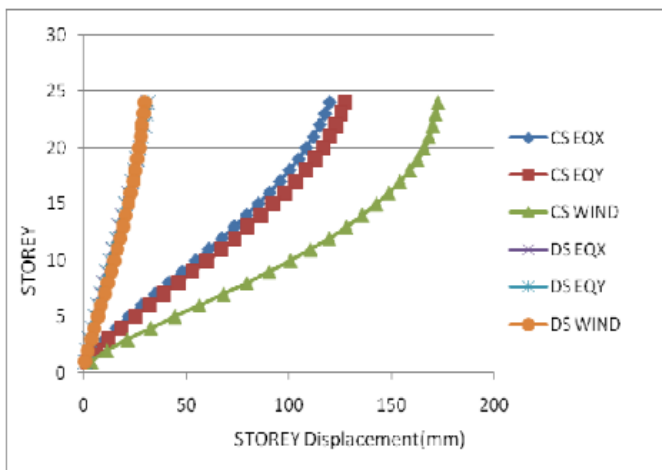

Chart -2.1. a: Displacement Comparison

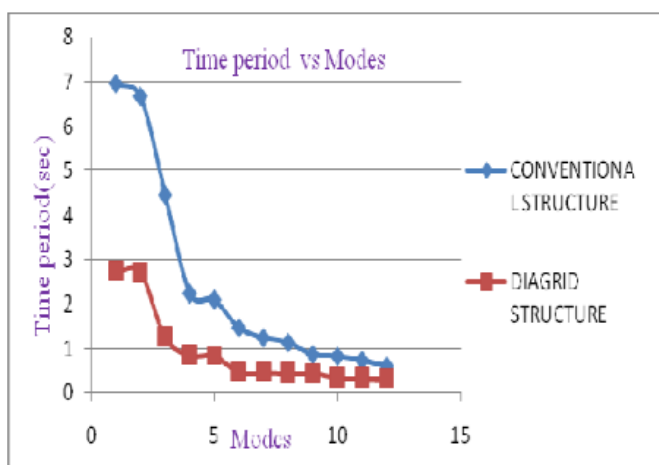

Chart -2.1. b: Natural Time Period Comparison

Review 2.2

Nishith B. Panchal (2014), "Optimum Angle of Diagrid Structural System" .in this paper, the comparison study of 24-storey, 36-storey, 48-storey and 60-storey of diagrid structural system with a diagrid angle 50.2°, 67.4°, 74.5° and 82.1° is studied.

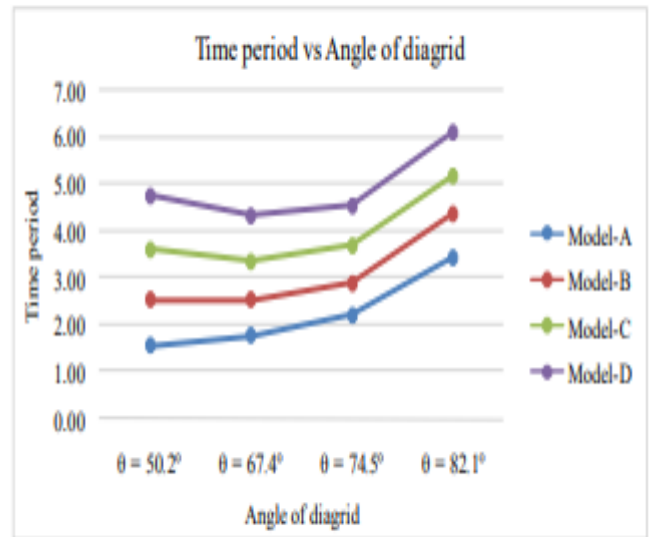

Chart -2.2. a: Diagrid angle vs time period

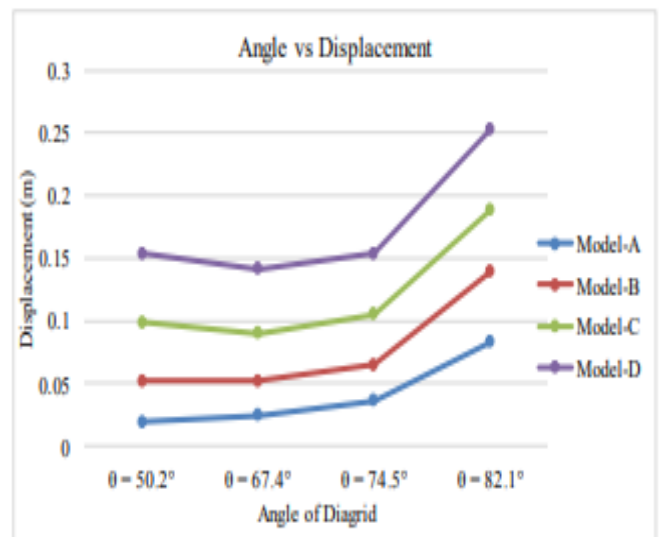

Chart -2.2. b: Diagrid angle vs Displacements

From this study it is conclude that, first mode time period is minimum for angle region 65° to 75°, Diagrid angle in the region of 65° to 75° provides more stiffness to the diagrid structural system which reflects the less top storey displacements, also it provides more economy in terms of consumption of steel.

Review 2.3

Tremblay R, Poncet L, Bolduc P, Neville R and DeVall R (2004). This paper presents qualifying tests performed on two Buckling Restrained Brace (BRBs) members and describes an analytical study carried out to evaluate the seismic performance of structures equipped with these members. In the analytical study, the seismic performance of a 3-storey structure with buckling restrained braces is evaluated and compared to that of the same building designed with conventional steel braces.

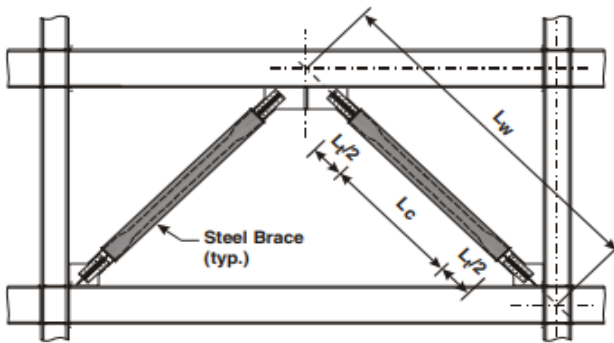

Fig -2.3. a: Typical buckling restrained braced frame and buckling restrained brace.



Fig -2.3. b: Brace specimen in the test frame.

According to this paper, the results of two sub-assembly tests indicated that properly detailed and fabricated buckling restrained braces with core plates made from steel with enhanced toughness properties possess residual low-cycle fracture life capacity after the application of a qualifying seismic test protocol with cyclic core strain deformations of up to 3.5%. Also the reduction in storey drifts also observed.

Review 2.4

Naveed Anwar, Jose A, Thaung Htut, Deepak Rayamajhi (2014), "Application of Buckling Restrained Braces in 50-Storey Building". In this paper the first application of these devices in a major high rise building in the Philippines 50 storey building with ductile core wall and BRBF system is investigated.

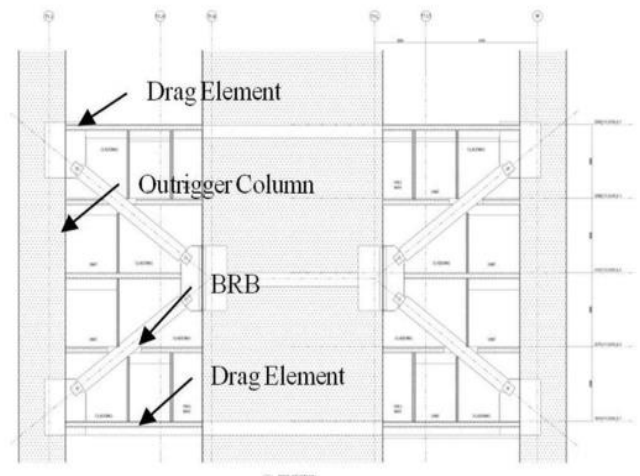

Fig -2.4. a: Typical BRB System

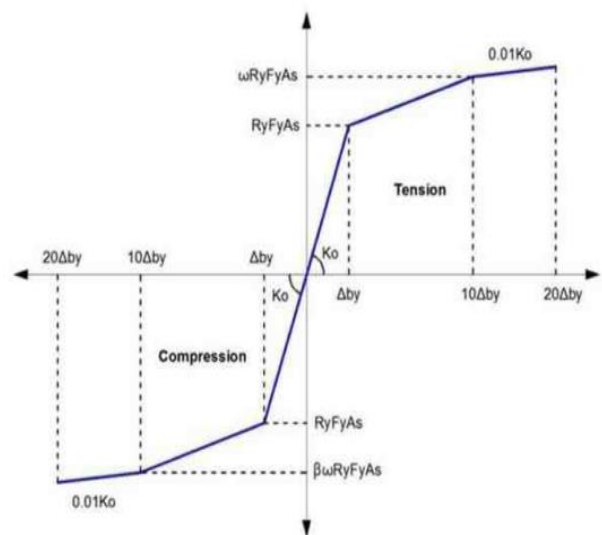

Fig -2.4. b: Assumed Backbone curve for BRB

According to this paper it has concluded that, the storey drift of the building reduces while using BRBF, the maximum storey drift for both principle direction was observed less than 3% which is acceptable limit. The Base shear was also observed to be less with the BRBF. It has also found that all the BRBs have average ductility demand less

than 9, which is maximum allowable ductility demand for primary braces components mentioned in ASCI 41-06.

3. NEED OF BRBF IN DIAGRID SYSTEM

The concentrically braced frame is one of the most efficient lateral-load resisting systems. However, they are known to be prone to many non-ductile modes of behavior when subjected to large ductility demands. Such modes include connection failure, member fracture, and severe loss of strength and stiffness due to beam ductility from unbalanced tension and compression strengths. Traditionally, concentrically braced frame have been treated as high-strength, low-ductility systems.

As diagrid system has many advantages like, it is stiff, it is efficient, and also has better resistance to lateral displacements. But it doesn't have much ductility, this property can be enhanced by combining the structural diagrid system with buckling restrained braces.

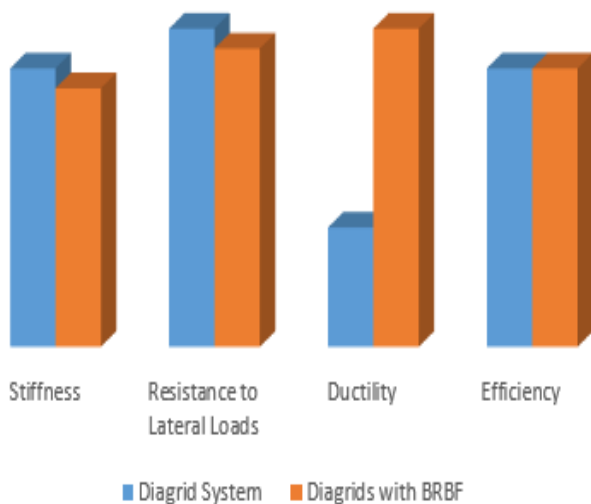

Chart -2: Diagrid System Vs Diagrid system with BRBF

3. CONCLUSIONS

Various researches have made in related to Structural diagrid system and Buckling Restrained braced framed separately, but the combined effect of the structure has to utilize in order to improve the performance of the buildings.

The diagrid system alone has many advantages as discussed earlier except ductility property. Combining the Buckling Restrained Braces in the Diagrid system will results in improvement in ductility, hence it will enhance the performance of the structure.

REFERENCES

- [1] Harish varsani (2015) "Comparative Analysis of Diagrid Structural System and Conventional Structural System for High-rise Steel Building(IJAREST), Volume 2, Issue 1, January- 2015
- [2] Nishith B. Panchal (2014), "Optimum Angle of Diagrid Structural System". (IJETR) Volume-2, Issue-6, June 2014
- [3] Tremblay R, Poncet L, Bolduc P, Neville R and DeVall R (2004) J13th World Conference on Earthquake Engg Vancouver B.C. Canada August 1-6, 2004.
- [4] Naveed Anwar, Jose A, Thaung Htut, Deepak Rayamajhi (2014), "Application of Buckling Restrained Braces in 50-Storey Building". International journal of high rise buildings volume 3 number 1.
- [5] Rafael Sabelli, S.E. and Walterio López, S.E." Design of Buckling-Restrained Braced Frames" _Modern Steel Construction, March 2004
- [6] AISC 341-10, Seismic Provisions for Structural Steel Buildings June 2010.

BIOGRAPHIE



Kashif Ansari
Design and Engineering Dept.
JSW Severfield Structures Ltd
Mumbai.