

ANTI ISLANDING PROTECTION WITH DISTRIBUTED GENERATOR USING SEMICONDUCTOR

Anandalakshmi A P¹, Sreenivas P²

¹M.Tech student, Energy Management, Govt. Model Engineering College, Kerala, India

²Associate Professor, Mechanical Engineering, Govt. Model Engineering College, Kerala, India

Abstract - The advancement in power generation such as wind turbine, fuel cell, photovoltaic, new innovations in power electronics and consumer demands for better power quality and reliability are forcing the power industry to focus towards Distributed Generations (DG). DG has recently gained momentum in the power industry due to market deregulations and environmental concerns. Islanding occurs when a portion of the distribution system becomes electrically isolated from the remainder of the power system yet continues to be energized by distributed generators. An important requirement to interconnect a DG to power distributed system is the capability of the DG to detect islanding. Failure to trip islanded generators can lead to various problems to the generators and the connected loads. The present industrial practice is to disconnect all distributed generators immediately after the occurrence of islands. To achieve such a goal, each distributed generator must be equipped with devices to prevent islanding called anti islanding. In this project, semiconductor switch based anti-islanding protection device to isolate the DG side generation is simulated in MATLAB-SIMULINK and various responses are evaluated. The waveform generated shows lower spikes in the switching response.

Key Words: Distributed Generation, Anti-islanding, Semiconductor, Photovoltaic

1. INTRODUCTION

During the past few years, the energy market worldwide has been encouraging the use of renewable sources. As a result, the number of small-scale generators connected directly to the distribution system has increased. This improved the power system stability and the power quality supplied to the customers [1, 2]. It also reduces power loss and hence to reduce energy cost even though the distributed generator possess some challenges to workers. Distributed Generation (DG) is an electric power source connected directly to the distribution network or on the customer site of the meter [3]. Many kinds of DG systems can be connected to the grid [4]. The main advantage of DG system is that it can be renewable such as other source of energy. They are more economical and efficient in feeding the peak load. When it is connected to grid, islanding should be taken into account [5]. Besides these issues, the possible islanding operation condition of DG, which takes place when the connection to the utility grid is lost and the distributed generator remains supplying the loads as an islanded grid, is also a concern. Islanding is a critical and unsafe condition in which a

distributed generator, such as a solar system, continues to supply power to the grid while the electric utility is down. Also it exposes utility workers life to critical dangerous of shocks and burns, who may think that there is no power once the utility power is shut down, but the grid may still be powered due to DGs. To avoid this problem, it is recommended that all DGs shall be equipped with devices to prevent islanding. This is called anti-islanding.

The existing methodologies for islanding detection and prevention can be divided into two categories: active methods and passive methods [5, 6]. Grid interconnection of photovoltaic (PV) power generation system has the advantage of immediate and efficient utilization of generated power [7]. However, the technical requirements from the utility system side need to ensure the safety of the PV system installer and the reliability of the utility grid [8]. Clarifying the technical requirements for grid interconnection and solving the problems are therefore very important issues for widespread application of PV systems.

Large distributed generators are usually connected to Medium Voltage (MV) feeders. The anti-islanding protection depends on the transfer trip from transformer station. In the existing system it presents a local anti-islanding protection relay as a backup for transfer trip [9]. Relay is a mechanical contact device, so there exists some issues like surge and spark.

This paper presents an approach to the anti-islanding protection using semiconductor switch in DG side. The semiconductor switch selected for this study is Insulated Gate Bipolar Transistor (IGBT) which is a non-mechanical contact device. The introduction of IGBT into the DG helps to reduce the voltage spikes associated with switching.

2. OPERATION PRINCIPLE OF THE TYPICAL ANTI-ISLANDING SCHEME

Fig.1 shows a typical medium voltage (MV) distribution system. High voltage transmission network supplies two loops L1 and L2 with power substation to power MV feeders, such as M1, M2, and etc., to guarantee high power distribution reliability. In feeder M1, diverse DGs, such as PV-DG, WT-DG, and MT-DG, could be connected by circuit breakers (CB) at different sites. Lumped elements Line 1, Line 2 and Line 3 are the line impedances, and Load 1, Load 2 and Load 3 represent the equivalent loads, respectively. Once the feeder CB is opened because of some reasons, or

- Current Regulator: Based on the current references I_d and I_q (reactive current), the regulator determines the required reference voltages for the inverter. In our example, the I_q reference is set to zero.
- PLL & Measurements: Required for synchronization and voltage/current measurements.
- PWM Generator: Generate firing signals to the IGBTs based on the required reference voltages. In our example, the carrier frequency is set to 1980 Hz (33×60).

The initial input irradiance to the PV array model is 1000 W/m² and the operating temperature is 45°C. When steady-state is reached (around t=0.15 sec.), we get a PV voltage (V_{dc_mean}) of 481 V and the power extracted (P_{dc_mean}) from the array is 236 kW. These values correspond very well to the expected values from the PV module manufacturer specifications.

At t=0.3 sec, sun irradiance is rapidly ramped down from 1000 W/m² to 200 W/m². Due to the MPPT operation, the control system reduces the V_{DC} reference to 464 V in order to extract maximum power from the PV array (46 kW).

Grid Isolation (IG) detected by grid voltage and current measurement and control applied to the IGBT system is shown in Fig 4.

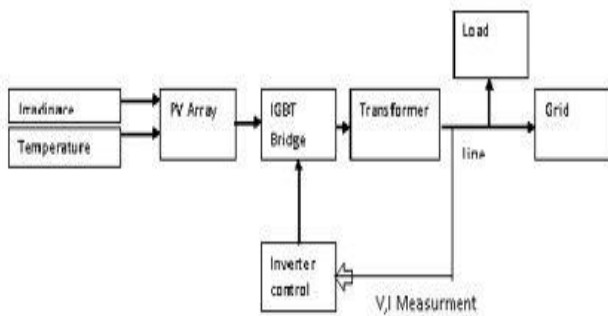

Fig -4: Representation of IGBT control from IG Detection

4. RESULTS AND DISCUSSION

4.1 IG protection in Wind Grid System

Fig. 5 shows the phasor simulation result of wind grid system in normal condition, the load flow is according to the wind data applied as the simulation input. Fig. 6 shows the response of the DG system separately from the wind grid system.

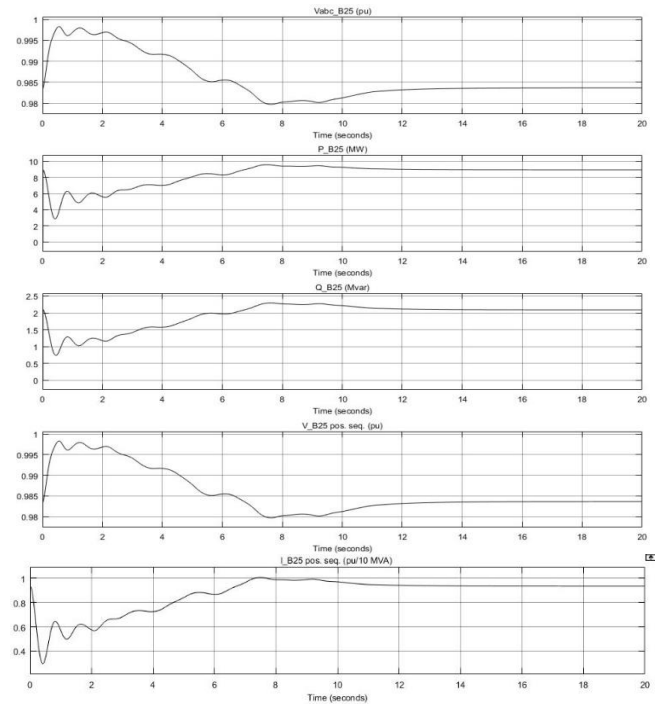

Fig -5: Phasor response of wind grid system in normal case

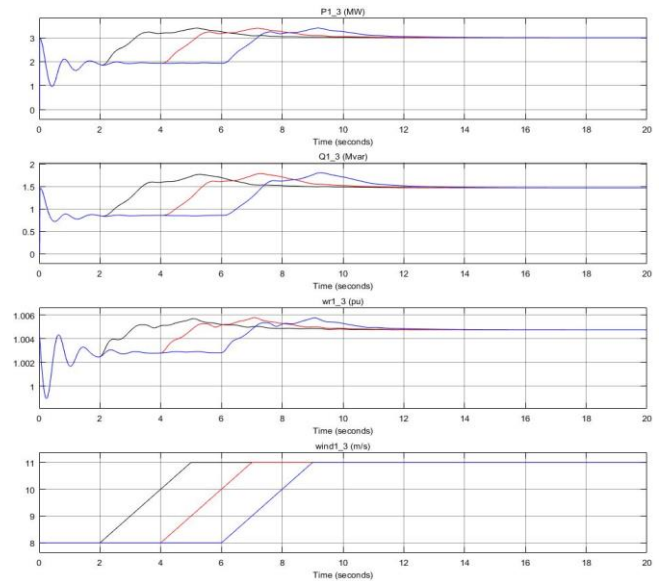

Fig -6: Phasor response of wind DG system in normal case

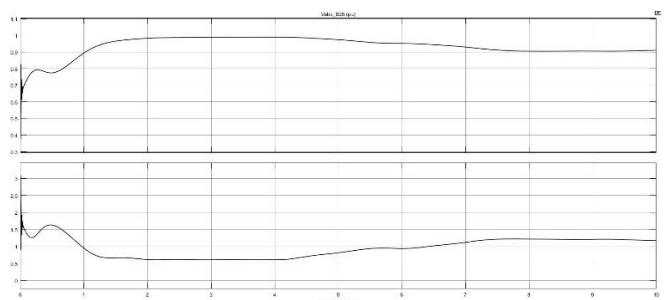

Fig -7: Wind Grid system Load flow

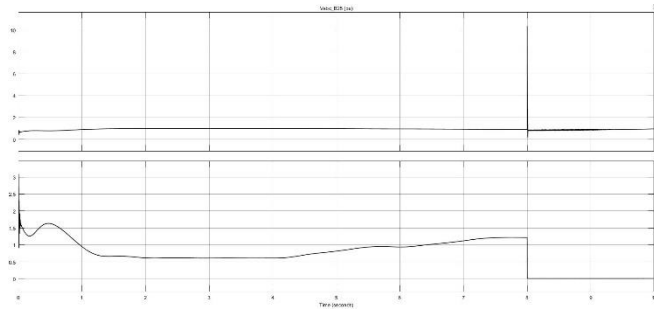

Fig -8: Wind Grid system Load flow in trip condition

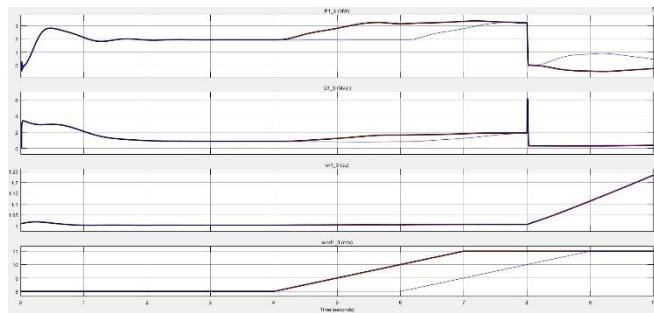

Fig -9: DG system Load flow in trip condition

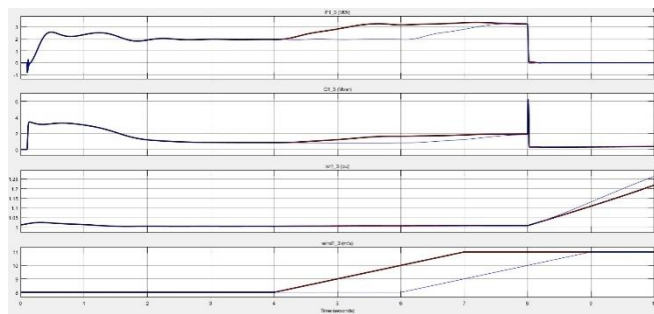

Fig -10: DG system Load flow in controlled condition

Compare the results shown from fig.7 to fig.10, a fault or tripping action occurred at a $t=8$, and the Grid load flow down to zero as show in fig.8. If the protection is not applied to the system, a load flow still exist in the DG side as shown in fig.9. When the protection applied by controlling the IGBT system, the load flow in the DG system is also down to zero as shown in fig 10.

4.2 IG protection in PV Grid System

As PV system is simulated using discrete models, the response shown in fig.11(a) and (b) are the V and I measurement at Grid and DG system respectively.

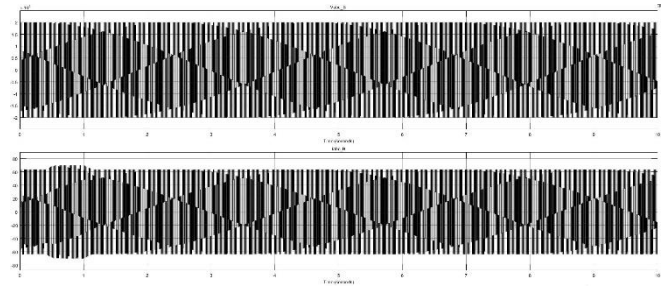

Fig -11: (a)

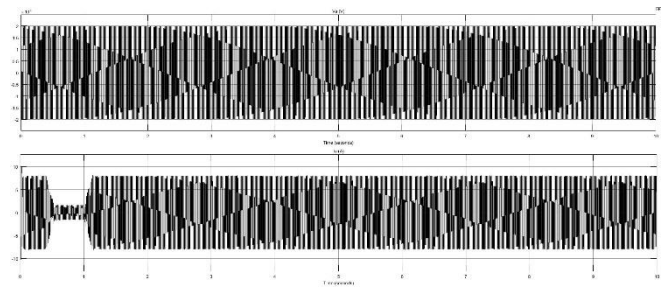

Fig -11: (b)

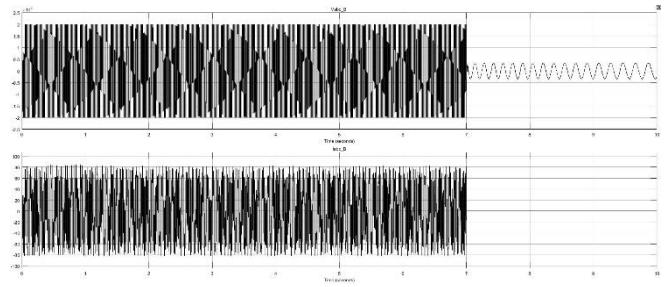

Fig -12: (a)

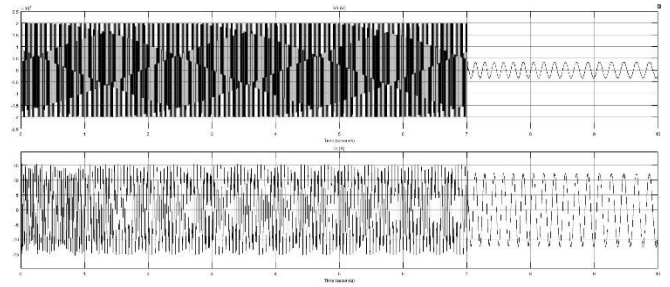
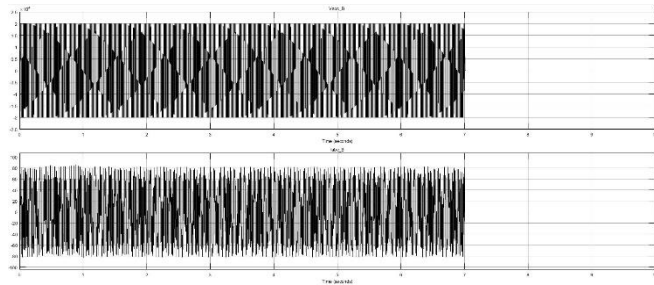
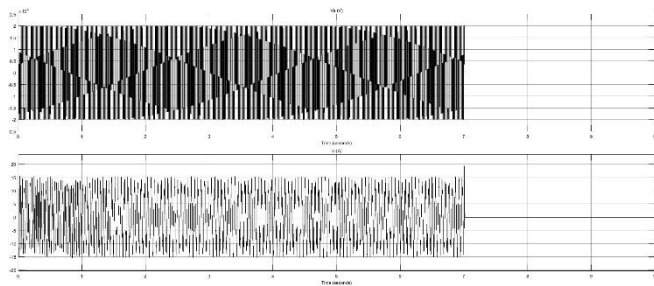

Fig -12: (b)

When a fault or trip occurred in the Grid at $t=7$, and the DG is isolated, but the DG system is still active as shown in fig.12 (b).

When applying the measurement and feedback to the IGBT inverter system, the output from the DG side is controlled by applying protection logic as shown in fig 13(a) and (b).

Fig -13: (a)

Fig -13: (b)

5. CONCLUSION

Following the increased number and enlarged size of distributed generating units installed in a modern power system, the protection against islanding has become extremely challenging nowadays. Anti-islanding protection has been a major concern for grid connected PV systems. If the DG system is inverter based, then there will be a semiconductor system using MOSFET, IGBT etc. It can control the driving mechanism of the same semiconductors by IG Detection using existing detection methods. This can avoid the use of a separate tripping system and hence cost and maintenance are reduced. Hence, using the semiconductor for controlling the surge occurred at the time of tripping is also reduced.

REFERENCES

- [1] J. C. M. Vieira, W. Freitas, W. Xu, A Morelato, "An Investigation on the Non detection Zones of Synchronous Distributed Generation Anti-Islanding Protection," IEEE Trans. On power delivery, vol. 23, no. 2, Apr. 2008.
- [2] A.Y. Hatata, El-H. Abd-Raboh, B. E. Sedhom, "A Review of Anti-islanding Protection Methods for Renewable Distributed Generation Systems," Journal of Electrical Engineering.
- [3] T Ackermann, G Andersson, L Soder, "Distributed generation: a definition," Electric Power Systems Research 57 (2001) 195-204.
- [4] C.N. Papadimitriou, V.A. Kleftakis, N.D. Hatziaargyriou, "A novel islanding detection method for microgrids based on variable impedance insertion," Electric Power Systems Research 121 (2015) 58-66.

- [5] P Paliwal, N.P. Patidar, R.K. Nema, "Planning of grid integrated distributed generators: A review of technology, objectives and techniques," Renewable and Sustainable Energy Reviews (2014) 557-570.

- [6] Y Jin, Q Song, W Liu, "Anti-islanding Protection for Distributed Generation Systems Based on Reactive Power Drift," 2009.

- [7] R Varier, N.M. Pindoriya, "A Novel Active Anti-Islanding Protection Scheme for Grid-Interactive Roof-Top Solar PV System," 2014.

- [8] H.N. Aghdam, N. Ghadimi, P. Farhadi, F. Hashemi, R. Ghadimi, "Detecting the Anti-Islanding Protection based on combined changes of Active and Reactive Output Powers of Distributed Generations," 2011.

- [9] H. Xiao, Z. Fang, C. Li, D. Xu, B. Venkatesh, B.N. Singh, "Anti-Islanding Protection Relay for Medium Voltage Feeder with Distributed Generator," IEEE Electrical Power and Energy Conference (EPEC), 2016.

- [10] A.M. Atallah, A.Y. Abdelaziz, R.S. Jumaah, "Implementation of perturb and observe mppt of PV system with direct control method using buck and buck boost converters," Emerging Trends in Electrical, Electronics & Instrumentation Engineering: An international Journal (EEIEJ), Vol. 1, No. 1, February 2014.