

EXPERIMENTAL INVESTIGATION OF METHODS TO IMPROVE PERFORMANCE OF DI ENGINE USING PONGAMIA BIODIESEL BY VARYING PARAMETERS

¹BANASHANKARI NIMBAL, ²Dr. M. C. NAVINDGI

¹M.Tech Scholar in Thermal Power Engineering, Department of Mechanical Engineering, PDA College of Engineering, Kalaburagi-585102 VTU Belagavi, INDIA

²Professor in Department of Mechanical Engineering, PDA College of Engineering kalaburagi-585102, INDIA

ABSTRACT - In this present work experimental investigation of method to improve performance of DI engine using pongamia biodiesel by varying parameters. A single cylinder water-cooled four stroke diesel engine was used. The pongamia is blended with diesel in the proportions of B0, B20, B40 and B100 with different injection pressure 180 bars, 200bar and EGR (Exhaust Gas Recirculation) at 5% & 10%. The performance of DI engine using pongamia biodiesel blends are evaluated by operating the engine at different load conditions. The performance parameters such as Specific Fuel Consumption (SFC), Brake Thermal Efficiency (BTE) and Exhaust Gas Temperature (EGT), were evaluated. Further, the exhaust emissions such as oxides of nitrogen (NO_x) unburned hydrocarbon (HC), carbon monoxide (CO), carbon dioxide (CO₂), and smoke and combustion parameters such as pressure (P in bar), heat release rate (HRR), cumulative heat release rate (CHRR), were measure. It is found that pongamia biodiesel blend (B40) showed slight increase in brake thermal efficiency with the reduction of exhaust gas temperature, less fuel consumption. Further, it is found that the slight reduction in NO_x emission and smoke emission. It is also found that reduction in HC and CO, CO₂, and emission was achieved. Hence, it is concluded that pongamia biodiesel (B40) can be used as, alternate fuel for DI diesel engine without any major modification.

Key words: Diesel engine, biodiesel, pongamia oil, engine performance; emission; combustions.

1. INTRODUCTION

According to the natural scenario, diesel engines are used to power automobiles, locomotives, ships and trucks, irrigation pumps, buses and personal vehicles, generator [1]. It is also used widely to generate electric power. The diesel engine has the highest thermal efficiency. Due to these advantages, the environmental pollution caused by diesel engines becomes a major concern throughout the world. Diesel engines produce carbon monoxide (CO), carbon dioxide (CO₂), hydrocarbon (HC), and smoke. Recent advances in production and changes in the political climate have increased the availability and awareness of biodiesel. Since the development of the diesel engine, the use of fatty materials and their derivatives have been pointed out as

possible fuels. Indeed the use of neat fats and oils as well as fatty acid mono alcohol esters (biodiesel) and hydrocarbons obtained after the cracking of fatty materials have been proposed as suitable fuels for these engines. Note that, although direct use of vegetable oil was demonstrated as feasible in the first half of the 20th century, due to their high viscosity, density, and deposit build up, engine failure can occur in modern engine. The ozone layer is damaged due to this environmental pollution and also it is difficult survive in the atmosphere with health concept. By using biodiesel with diesel fuel it's reduces the viscosity, density, and increase the thermal efficiency, and avoids the engine failure, produces low emission. Diesel engines are the major source of transportation, power generation, and marine applications etc. The rising the Prices and dwindling reserves of conventional fuels have studies on the use of an alternative fuels, alternative fuels are renewable like vegetable oils and alcohols. In fact early engines were demonstrative with vegetable oils. The suitability of an alternative fuels for a diesel fuel engine application has to be thoroughly investigated. Vegetable oils have some important properties like viscosity, density, calorific value, flash point and fire point similar to the diesel.

2. MATERIAL AND METHODS

Crude pongamia oil was collected locally and used. Chemical including methanol, sodium hydroxide (NaOH) and potassium hydroxide (KOH) are used without any purification. Pongamia is extracted from transesterification process to remove the moisture content.

2.1 Transesterification:

Biodiesel is commonly produced by the transesterification of the vegetable oil or animal fat feedstock, and other non-edible raw materials such as frying oil, etc. There are several methods for carrying out this transesterification reaction including the common batch process, heterogeneous catalysts, supercritical processes, ultrasonic methods, and even microwave methods.

Chemically, transesterified biodiesel comprises a mix of mono-alkyl esters of long chain fatty acids. The most

common form uses methanol (converted to sodium methoxide) to produce methyl esters (commonly referred to as Fatty Acid Methyl Ester – FAME) as it is the cheapest alcohol available, though ethanol can be used to produce an ethyl ester (commonly referred to as Fatty Acid Ethyl Ester – FAEE) biodiesel and higher alcohols such as isopropanol and butanol have also been used. Using alcohols of higher molecular weights improves the cold flow properties of the resulting ester, at the cost of a less efficient transesterification reaction.

A lipid transesterification production process is used to convert the base oil to the desired esters. Any free fatty acids (FFAs) in the base oil are either converted to soap or removed from the process, or they are esterified (yielding more biodiesel) using an acidic catalyst. After this processing, unlike straight vegetable oil, biodiesel has combustion properties very similar to those of petroleum diesel, and can replace it in most current uses.

TABLE 1: Properties of Pongamia Oil and Diesel

| Fuel properties | Diesel | Pongamia biodiesel |
|------------------------|--------|--------------------|
| Fuel density in(gm/cc) | 0.82 | 0.9 |
| Viscosity, cst | 3.6 | 6.9 |
| Calorific value(kj/kg) | 42000 | 39458 |
| Flash point °c | 67 | 175 |

3. EXPERIMENTAL SET-UP

The experiment set up consists of single cylinder water-cooled four stroke diesel engine conducted to eddy current dynamometer for variable loading at a constant speed 1500 rpm. It is provided with necessary equipment and instruments for combustion pressure, fuel injection pressure and crank angle measurements. These signals are interfaced to computer through engine indicator. The engine was coupled to a exhaust gas analyzer emission such as carbon monoxide (CO), carbon dioxide(CO₂), oxide of nitrogen (NO_x) were measured by exhaust gas analyzer. The experiments were carried out by using various blends of pongamia (B20,B40,B100) with diesel at different load conditions on the engine keeping all the independent variables same.

The variable tests are conducted for 0, 1, 2, 3, 4, and 5 kW at a constant speed of 1500 rpm with different injection pressure of 180 bars and 200 bars, and EGR (Exhaust Gas Recirculation) at 5% and 10%. Observations recorded were replicated thrice to get reasonable values. The performance characteristics of the engine are evaluated in terms of brake thermal efficiency (BTHE), specific fuel consumption (SFC), and exhaust gas temperature then emission characteristics of the engine are evaluated in terms of carbon monoxide (CO), carbon dioxide (CO₂), oxide of nitrogen (NO_x), and hydro carbon (HC), and combustion characteristics are evaluated in terms of pressure, crank angle, cumulative heat

release rate, and net heat release rate. These characteristics are compared with the results of diesel fuel.

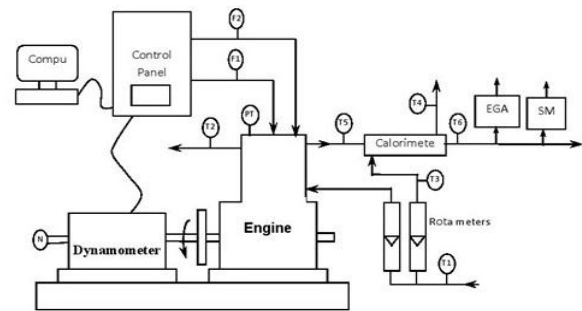

Fig 1: experimental set up

ENGINE SPECIFICATION

Table 2: Technical Specifications of the Kirloskar Diesel Engine

| Manufacturer | Kirloskar Oil Engine Ltd., India |
|--------------------|--|
| Model | TV – SR II, naturally Aspirated |
| Engine | Single cylinder, DI, water- cooled, four strokes |
| Bore/Stroke | 87.5 mm/110 mm |
| Compression ratio | 17.5:1 |
| Speed | 1500 r/min, constant |
| Rated Power | 5.2 kw |
| Injection pressure | 240 bar/23° BTDC |
| Type sensor | Piezo electric |
| Response time | 4 micro seconds |
| Make and model | Neptune equipments, India, OPAX200 II/DX200P |
| Crank angle sensor | 1 – degree crank angle |

4 RESULTS AND DISCUSSION:

The experiments were carried out on a test engine running on B0, B20, B40 and B100 fuels in order to investigate of method to improve performance, emission, and combustion characteristics. The engine started without any problem and it was running smooth.

All the experiment were conducted at constant speed of 1500 rpm under varying different loads like 0, 1, 2, 3, 4, and 5 kW varying load conditions for B0, B20, B40, and B100 fuels With different injection pressure 180 bars, 200 bar and EGR at 5% & 10%. The engine started without any problem and it was running smooth.

4.1 Performance characteristics:

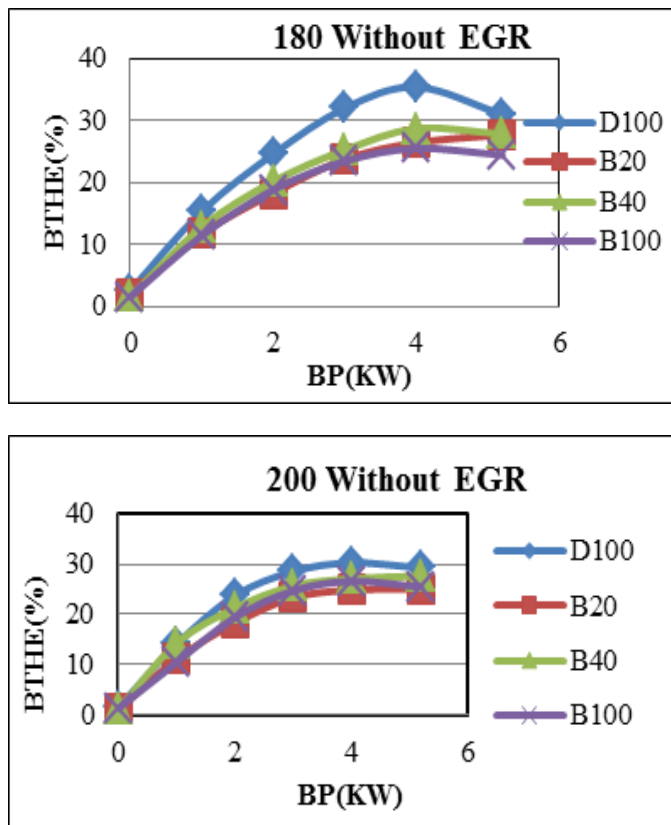

Fig. 2 Variation of brake thermal efficiency with brake power for pressure 180 bar and 200 bars without EGR.

Fig.2. shows the comparison of brake thermal efficiency with brake power for pressure 180 bars and 200 bars without EGR different blends of pongamia oil and diesel. As the load on the engine increases, brake thermal efficiency increase because brake thermal efficiency is the function of brake power and brake power increases as the load on the engine increases. The maximum brake thermal efficiency without EGR at 180 bars and 200 bars of pongamia oil B40 is 28% and 26%, against diesel which is 35% and 30% because of better spray characteristics in the combustion chamber. The decrease in B20, B100 brake thermal efficiency for higher blends may be due to the combined effect of its lower heating value, low calorific value, and increase in fuel consumption. The BTHE of pongamia blends were lower than that of diesel. For B40 the efficiency is closer to diesel and gives better performance with respect to other blends.

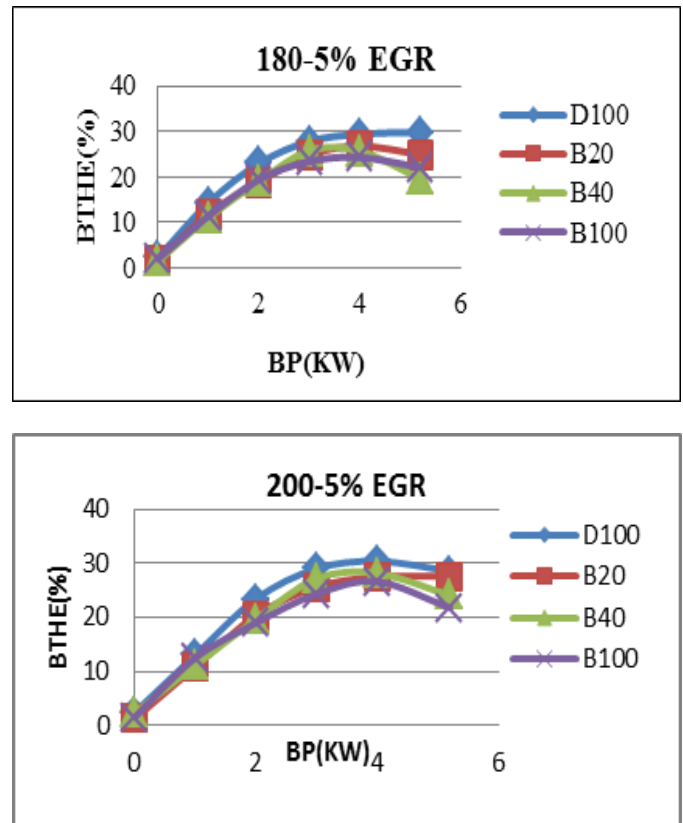
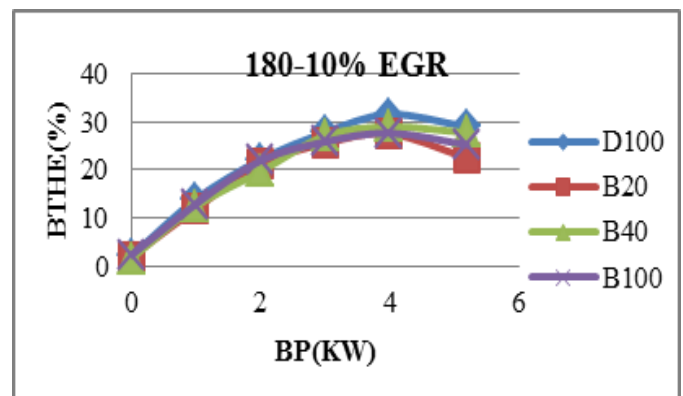

Fig. 3 Variation of brake thermal efficiency with brake power for pressure 180 bar and 200 bars with EGR at 5%.

Fig.3. shows the comparison of brake thermal efficiency with brake power for pressure 180 bar and 200 bars with EGR at 5% different blends of pongamia oil and diesel. It is observed that the higher brake thermal efficiency with EGR at 5% is obtained for 200 bars with 40% pongamia biodiesel compared with the 180 bar injection pressures. This is probably due to increased combustion velocity because of higher intake charge temperature with EGR. The BTHE of pongamia blends were lower than that of diesel. The decrease in B20 and B100 brake thermal efficiency for higher blends may be due to the combined effect of its lower heating value and increase in fuel consumption. The curve B40 is nearer to the diesel curve.



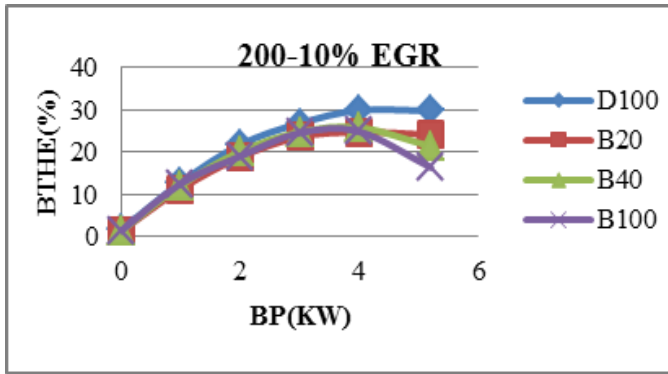

Fig: 4 Variation of brake thermal efficiency with brake power for pressure 180 bar and 200 bars with EGR at 10%.

Fig.4. shows the comparison of brake thermal efficiency with brake power for pressure 180 bar and 200 bars with EGR at 10% different blends of pongamia oil and diesel. As compared to the pressure 180 bar and 200 bars with EGR at 10% it was observed that brake thermal efficiencies of all the blends of pongamia biodiesel were found to be lower than diesel at all load levels. The BTHE with EGR at 10% for diesel with 180 bar 200 bars are 30% and 28.82%, pongamia biodiesel with 180 bars, and 200 bars are 26.64% and 24.06% respectively at full load. In full load 10% EGR, brake thermal efficiency was reduced by 2.58% because of More exhaust gases produced due to predominant dilution effect of EGR in combustion chamber results in efficiency drop.

Fig.5. shows the comparison of specific fuel consumption with brake power for 180 bar and 200 bars without EGR different blends of pongamia oil and diesel. Specific fuel consumption without EGR with 180 bars pressure under full load was found to be same value for biodiesel and diesel is 0.35 kg/kW-hr and 200 bars pressure under full load was found to be 0.37 kg/kW-hr for diesel and 0.42 kg/kW-hr for pure biodiesel, due to its lower heating value, greater density and hence higher bulk modulus. B20 has low SFC at higher load in 200 bars its due to the fuel consumption is less compared to other blends because of its high latent heat vaporization. B40 and B100 blends are high fuel consumption in 200 bars. As compared to all the blends B20 is the best blend for low fuel consumption.

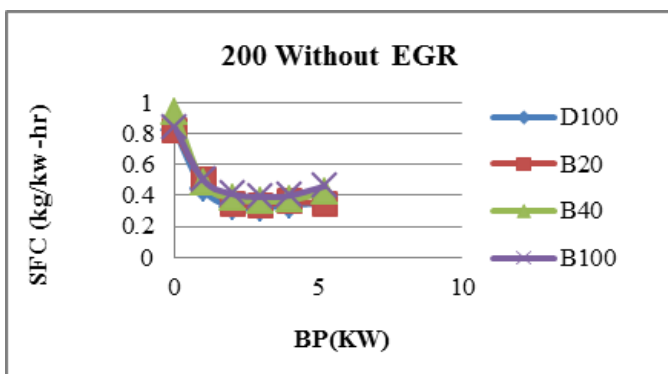
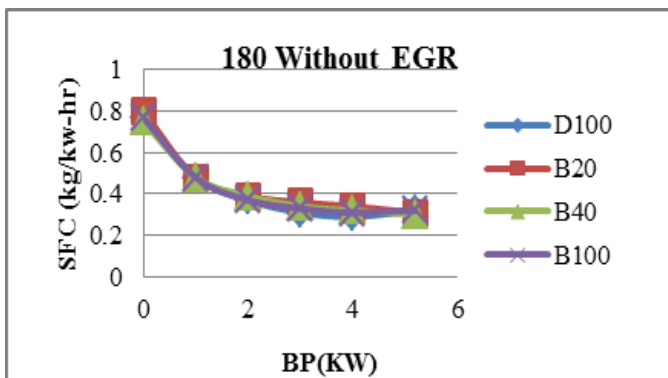

Fig: 5 Variation of specific fuel consumption with brake power for pressure 180 bar and 200 bars without EGR.

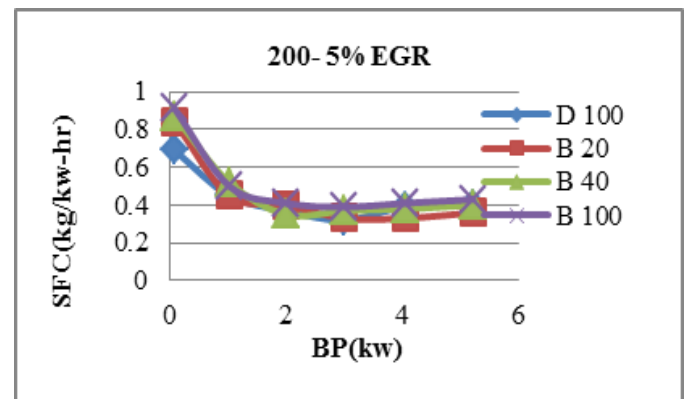
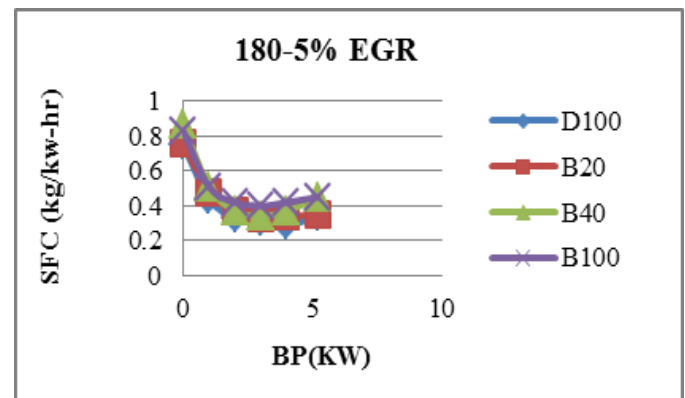

Fig: 6 Variation of specific fuel consumption with brake power for pressure 180 bar and 200 bars with EGR at 5%.

Fig.6 shows the comparison of specific fuel consumption with brake power at 180 bar and 200 bars with EGR at 5% for different blend conditions. It is seen that specific fuel consumption with EGR at 5% decreases when the load is increased for all operations of pongamia biodiesel and their blends. B20 is low specific fuel consumption in both the graphs it can also be observed that specific fuel consumption increases when pongamia proportion in the blend is increased for any given load, but the increase in specific fuel consumption for B100 operation is much more than that of other blends and diesel operations at higher load conditions due to the lower calorific value of the pongamia blends.

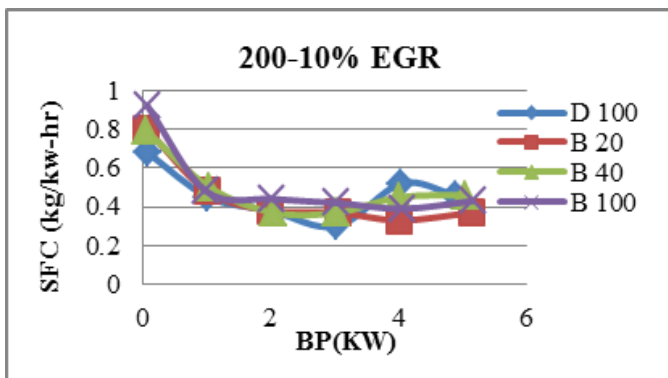
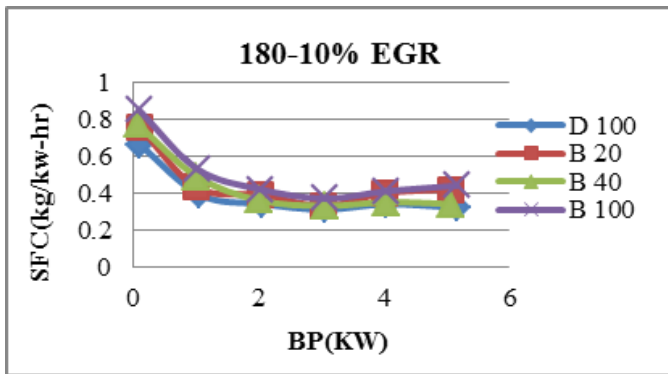

Fig. 7 Variation of specific fuel consumption with brake power for pressure 180 bar and 200 bars with EGR at 10%.

Fig.7 shows the comparison of specific fuel consumption with brake power at 180 bar and 200 bars with EGR at 10% for different blend conditions. Specific fuel consumption with EGR at 10% with 180 bars pressure under full load was found to be is 0.35 kg/kW-hr for diesel and 0.43 kg/kW-hr for pure diesel and 200 bars pressure under full load was found to be 0.42 kg/kW-hr for diesel and 0.41 kg/kW-hr for pure biodiesel, As shown in the fig 7 the Specific fuel consumption increased with higher level of EGR at 10% for all the blends of pongamia biodiesel and diesel. This is due to low calorific value of the fuel. Slightly higher values of biodiesel were due to lower calorific values and higher viscosity, density and boiling point.

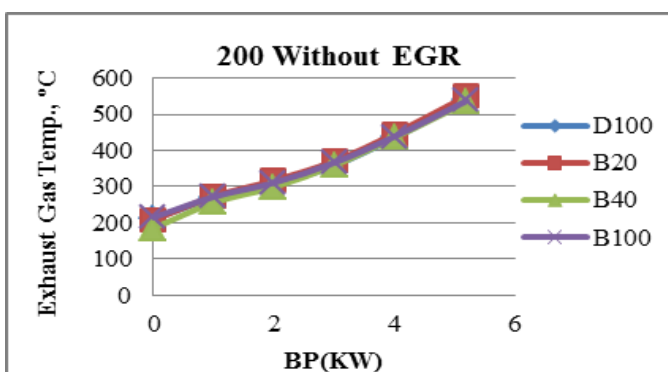

Fig. 8 Variation of exhaust gas temperature with brake power for pressure 180 bar and 200 bars without EGR.

Fig. 8 shows the comparison of exhaust gas temperature with brake power for 180bar and 200 bars without EGR different blends of pongamia oil and diesel. The exhaust gas temperature for all fuels tested increases with increase in the brake power. Exhaust gas temperature of all blends is higher as compared to diesel. The maximum EGT occurs at full load. From fig 8 show the Maximum EGT of B20 is 530 °C against 550 °C for that of diesel on normal engine in both the graphs. B40 and B100 is low EGT because of by increasing percentage of pongamia biodiesel in diesel decrease the EGT. It is observed that, at full load the exhaust gas temperature is high.

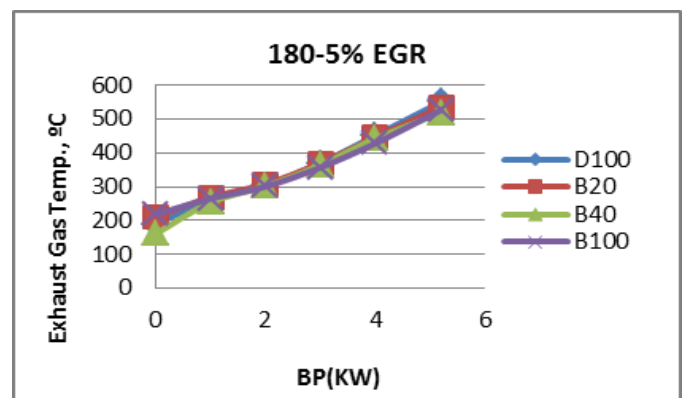
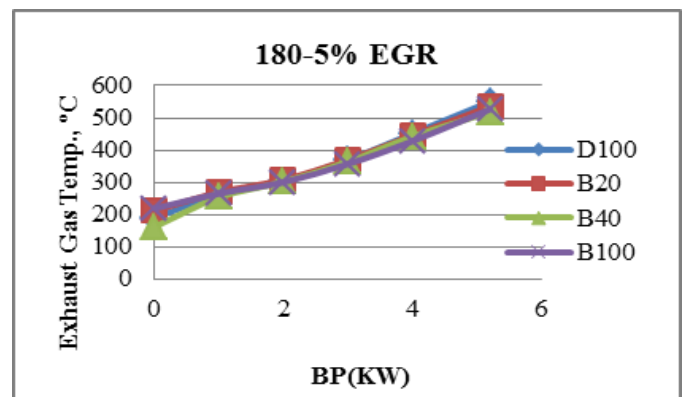

Fig. 9 Variation of exhaust gas temperature with brake power for pressure 180 bar and 200 bars with EGR at 5%.

Fig.9 shows the comparison of exhaust gas temperature with brake power for 180 bar and 200 bars with EGR at 5% different blends of pongamia oil and diesel. The EGT with EGR at 5% value for diesel at full load was 520 °C in 180 bars and 500 °C in 200 bars. It can also be observed that the values of EGT were 500 °C, 540 °C, 545 °C and 500 °C for B0, B20, B40 and B100 respectively at full load in both 180 and 200 bars graphs. As a result of increased combustion duration, a higher exhaust gas temperature is recorded for B20 blends in both graphs. With EGR at 5%, exhaust gas temperature was higher in biodiesel compare with diesel at all load conditions. The possible reason for this temperature increased may be relatively higher availability of oxygen in biodiesel for combustion.

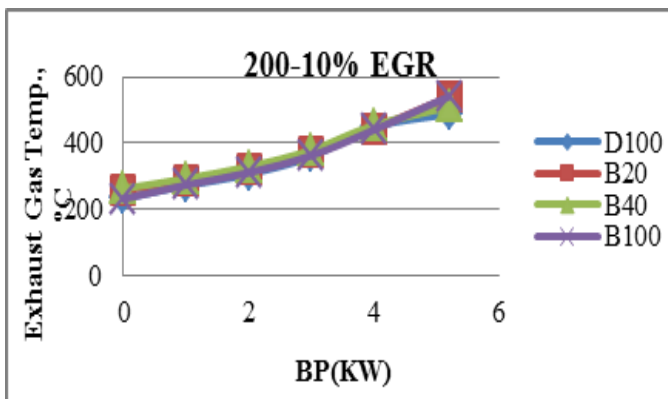
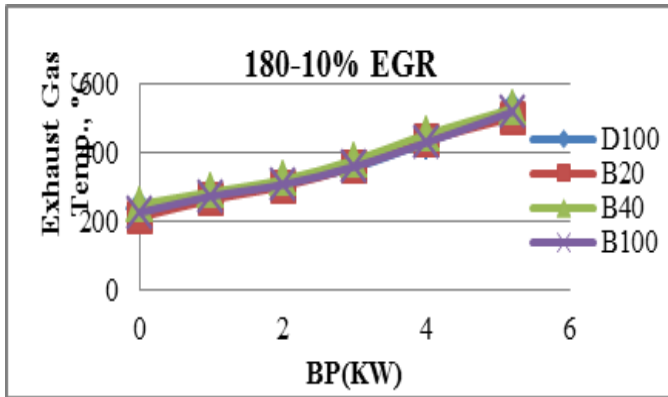

Fig: 10 Variation of exhaust gas temperature with brake power for pressure 180 bar and 200 bars with EGR at 10%.

Fig.10 shows the comparison of exhaust gas temperature with brake power for 180 bar and 200 bars with EGR at 10% different blends of pongamia oil and diesel. As shown in the fig 10 both 180 bars and 200 bars with EGR at 10% graphs are similar value is 520 °C for all the pongamia blends and diesel. It is evident from the graph that exhaust gas temperature is increased along with increase in load for all fuels. With EGR at 10%, exhaust gas temperature was higher in biodiesel compare with diesel at all load conditions. The possible reason for this temperature increased may be due to increasing the concentration of pongamia biodiesel for combustion.

4.2 Emission characteristics:

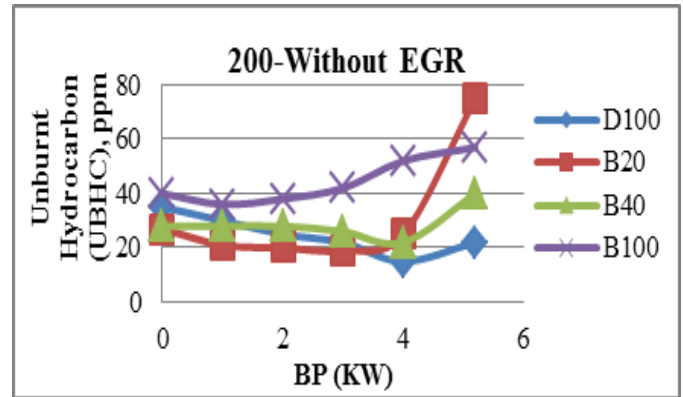
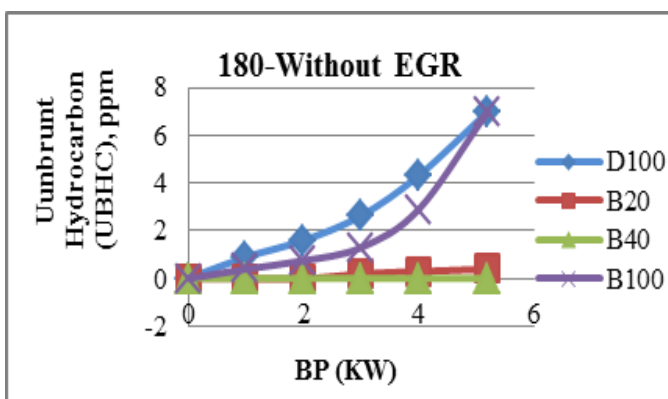

Fig: 11 Variation of unbrunt hydrocarbon with brake power for pressure 180 bar and 200 bars without EGR.

Fig.11 shows the variation of Unbrunt Hydrocarbon with brake power for pressure 180 bars and 200 bars without EGR different blends of pongamia oil and diesel. HC emissions decrease with increase in percentage of blend. Since the pongamia biodiesel, it promotes combustion and results in reduction in HC emissions it is observed that for B20 and B40 emission of HC is less than that of the diesel in both the graphs. The maximum HC of B40 is 0 ppm in 180 bars and 27 ppm in 200 bars against 7 ppm in 180 bars and 20 ppm in 200 bars for that of diesel. B20 and B40 blend gives lower emission with respect to other blends, due to the higher cetane number of biodiesel results decrease in HC shorter ignition delay.

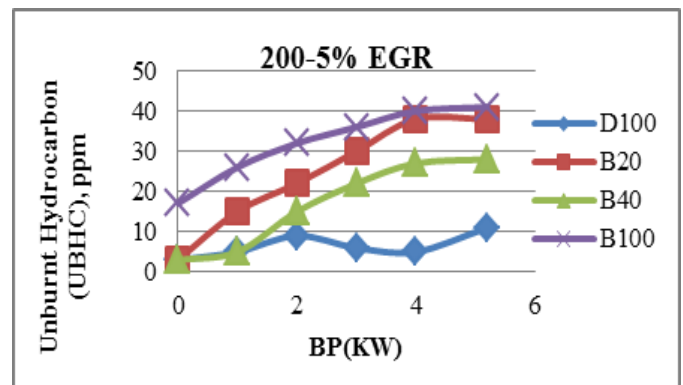
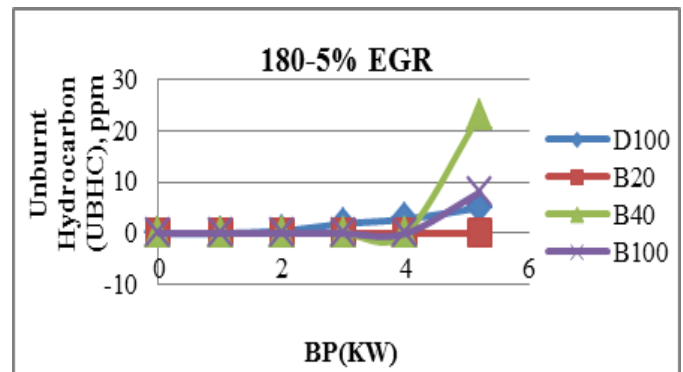

Fig: 12 Variation of unbrunt hydrocarbon with brake power for pressure 180 bar and 200 bars with EGR at 5%.

Fig.12 shows comparison of Unbrunt hydrocarbon with brake power for pressure 180 bar and 200 bars with EGR at 5% different blends of pongamia oil and diesel. The emissions of unbrunt hydrocarbon for biodiesel are high as compared to the diesel in both the graphs. As shown in the fig.12 B40 and B20 is low emission of HC in both graphs, low emission of unbrunt hydrocarbon in 180 bars as compared to the 200 bars injection pressure. The reason for this may be due to high injection pressure of the fuel is incomplete combustion. With EGR at 5%, exhaust gas temperature was higher in biodiesel compare with diesel at all load conditions. The possible reason for this temperature increased may be relatively higher availability of oxygen in biodiesel for combustion.

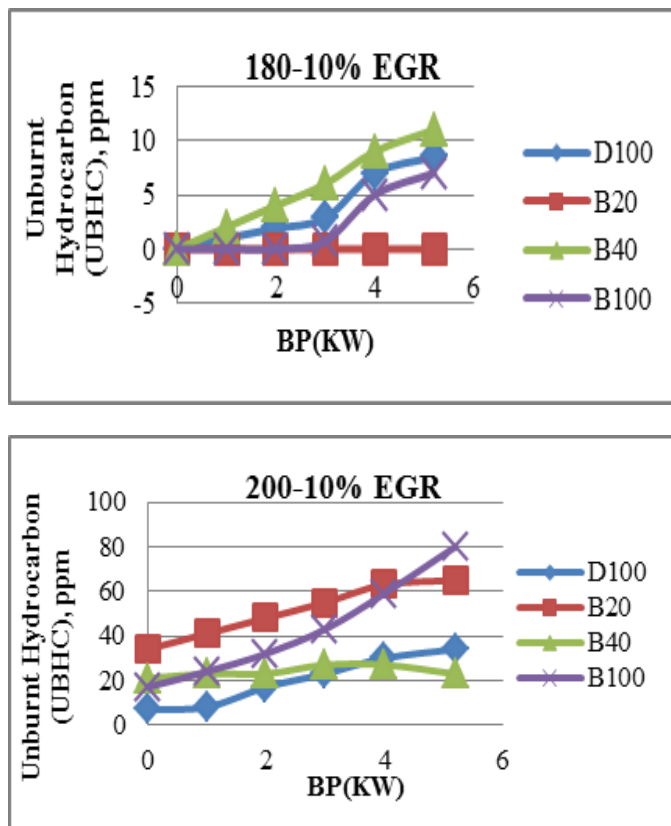

Fig: 13 Variation of Unbrunt Hydrocarbon with Brake Power for Pressure 180 Bar and 200 Bars with EGR At 10%.

Fig.13 shows comparison of Unbrunt hydrocarbon with brake power for pressure 180 bar and 200 bars with EGR at 10% different blends of pongamia oil and diesel. Hydrocarbons in exhaust are due to incomplete combustion of carbon compounds in the blends. However HC emission increases with increasing EGR rates. The emissions of unbrunt hydrocarbon for B20 exhaust are lower than that of diesel fuel in 180 bars and the pongamia biodiesel blends emission of HC is more than that of the diesel in 200 bars. This is due to reduction of oxygen concentration in inlet charge as EGR is introduced into the cylinder which makes the charge diluted. The possible reason for decrease in

unbrunt HC may be higher cetane number and increased gas temperature.

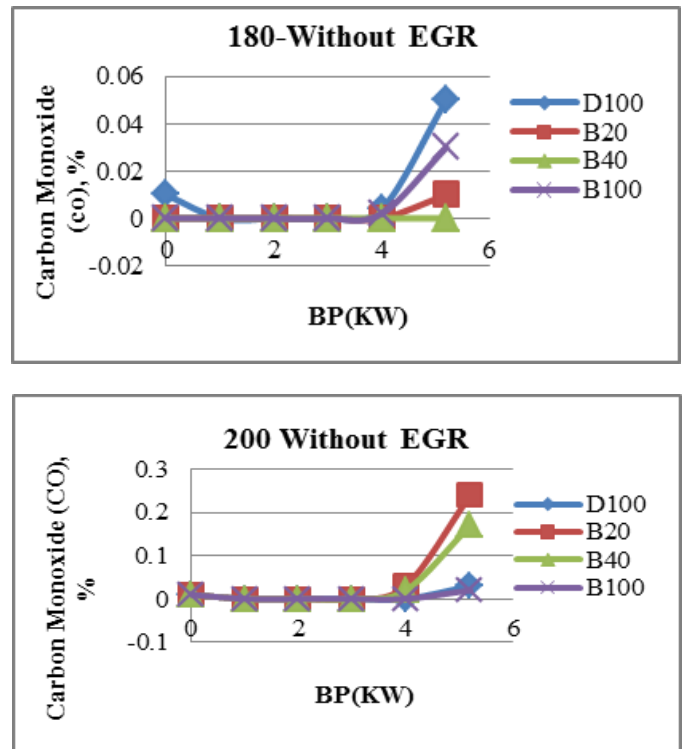
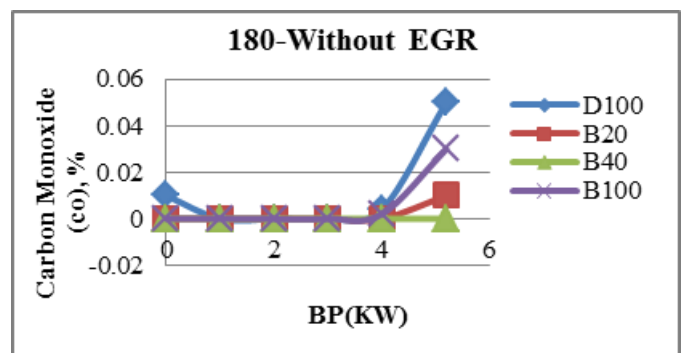

Fig: 14 Variation of carbon monoxide with brake power for pressure 180 bar and 200 bars without EGR.

Fig.14 shows comparison of CO with brake power for pressure 180 bar and 200 bars without EGR different blends of pongamia oil and diesel. The CO emission depends upon the strength of the mixture, availability of oxygen and viscosity of fuel. CO emission of diesel is higher in 180 bars and lower in 200 bars than that of the all the blends, expect the blend B40 which has a lower in both graphs. The decrease in carbon monoxide emission for biodiesel is due to more oxygen molecule present in the fuel and more atomization of fuel as compared to that of diesel. The maximum CO pure biodiesel is 0.03% volume against 0.05% volume pure diesel for pressure 180 bar. The maximum CO B20 is 0.22% volume against 0.03% volume pure diesel for pressure 200 bars. B40 blends give lower emission with respect to other blends.



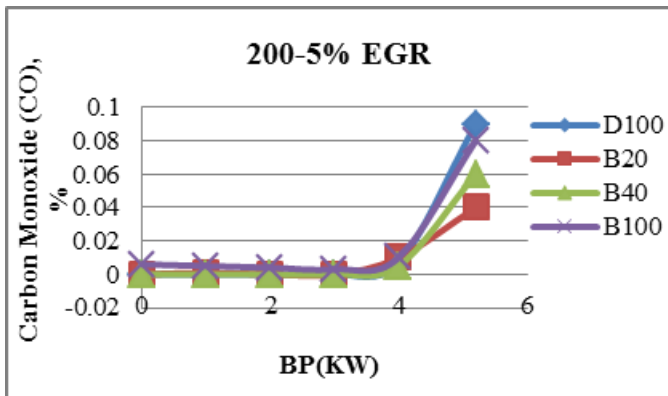
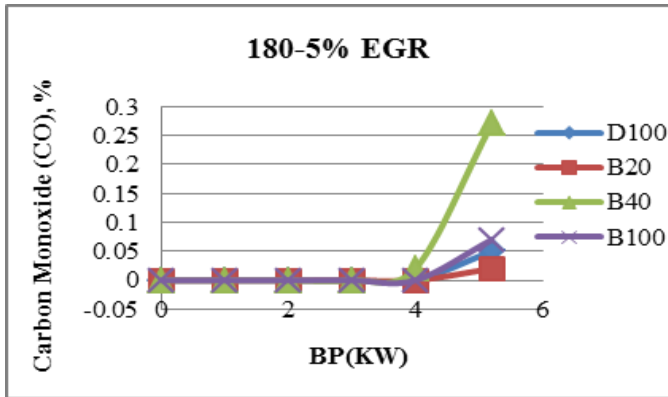

Fig: 15 Variation of carbon monoxide with brake power for pressure 180 bar and 200 bars with EGR at 5%.

Fig.15 shows comparison of CO with brake power for pressure 180 bar and 200 bars with EGR at 5% different blends of pongamia oil and diesel. CO emission of pure diesel and all blends is higher than that of the diesel, except B20 has a lower CO emission that of diesel in both graph. The maximum CO occurs at full load. Maximum CO of pure diesel is 0.07% against 0.05% in 180 bars and 0.09% in 200 bars injection pressure volume for that of diesel on normal engine. This increase in CO emission with EGR might be due to oxygen deficient operation. At 5% EGR for biodiesel a favorable reduction in CO emission can be seen at all loads.

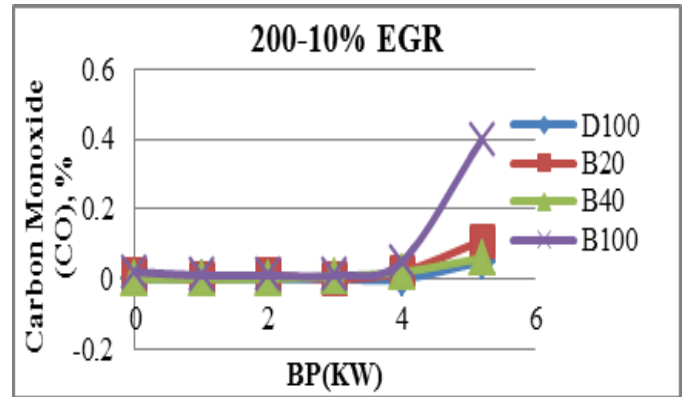
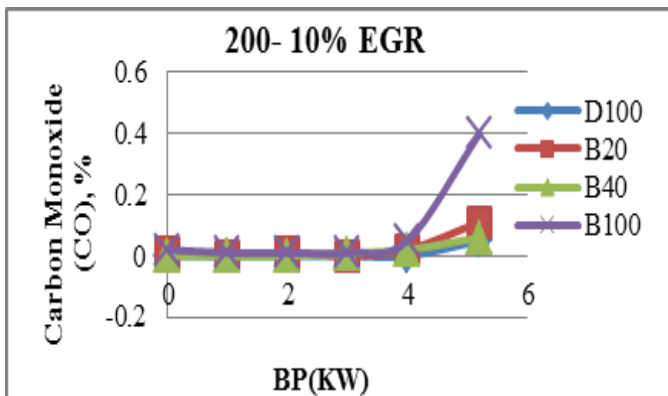

Fig: 16 Variation of carbon monoxide with brake power for pressure 180 bar and 200 bars with EGR at 10%.

Fig.16 Shows comparison of CO with brake power for pressure 180 bar and 200 bars with EGR at 10% different blends of pongamia oil and diesel. It can be seen from the figure that the higher CO emissions with EGR at 10% were obtained from pongamia biodiesel and its blends as compared to the diesel. The CO emission is 0.01%, 0%, 0.1% and 0.06% for pongamia biodiesel, B0, B20, B40 and B100 respectively in 180 bar injection pressure at 100% load and CO emissions is 0.1%, 0.05%, 0.4% and 0.04% for 200 bars injection pressure at 100% load. This is due to fact that high EGR flow rates at 10% results in deficiency of oxygen in combustion process and incomplete combustion tends to increase CO emissions. Increasing EGR flow rates at 10% results in rise of CO emissions.

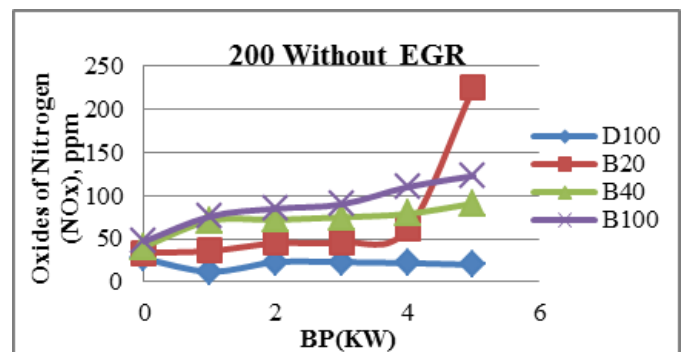
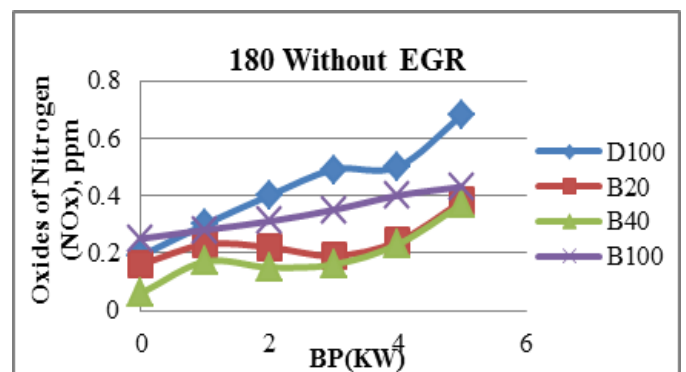

Fig: 17 Variation of carbon monoxide with brake power for pressure 180 bar and 200 bars without EGR.

Fig.17 shows comparison of CO with brake power for pressure 180 bar and 200 bars without EGR different blends of pongamia oil and diesel. The NOx values as parts per million, the NOx emission for diesel is higher than that of the all blends in 180 bars pressure and pongamia biodiesel and its blends are higher emission than that of the diesel in 200 bars pressure, this may be due to the availability of the excess oxygen present in pongamia biodiesel. As compared to the both graphs B20 and B40 has lower emission than that of the diesel as the load increases but the NOx emission increases for B0 in 180bars and B100 in 200 bars injection pressure.

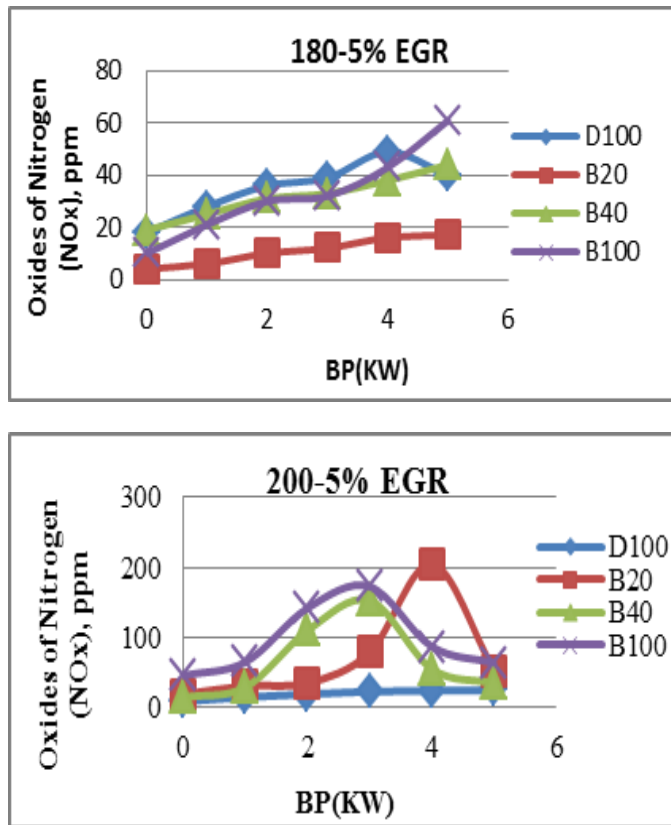

Fig: 18 Variation of carbon monoxide with brake power for pressure 180bar and 200bars with EGR at 5%.

Fig.18 Shows comparison of CO with brake power for pressure 180 bar and 200 bars with EGR at 5% different blends of pongamia oil and diesel. The exhaust gas temperature with blends having high percentage of pongamia oil is high as compared to diesel at higher loads. As compared to the both graphs pongamia biodiesel and its blends has lower emission in 180 bars and diesel has lower emission in 200 bar injection pressure. B20 is 18 ppm and 50 ppm and B40 is 40 ppm and 45 ppm has lower emission of NOx in both graphs. With increase in EGR level at 5% NOx level was reduced. Also reductions in brake thermal efficiency were observed. Thus it decreases the temperature rise for the same heat release in the combustion chamber results in lower NOx emission with EGR.

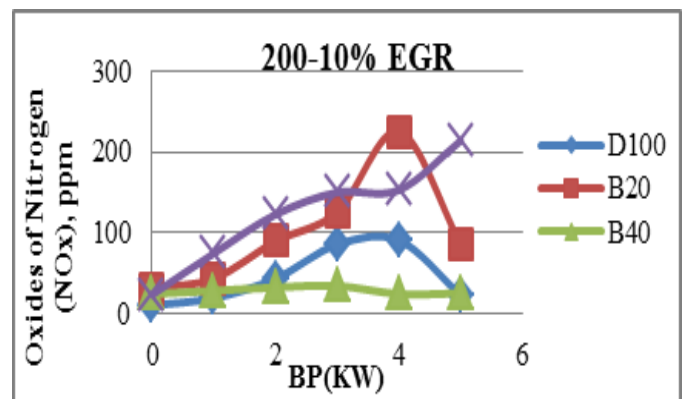
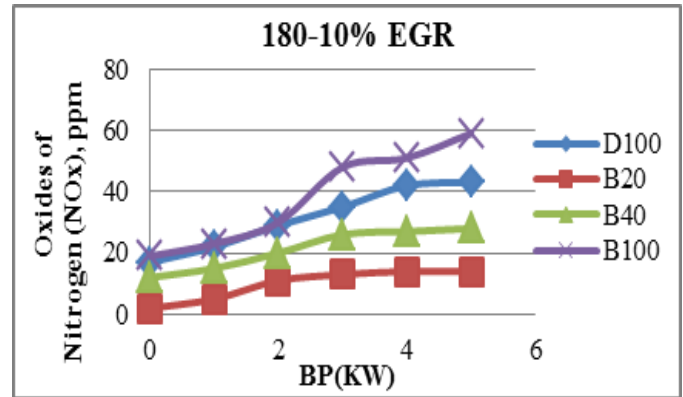
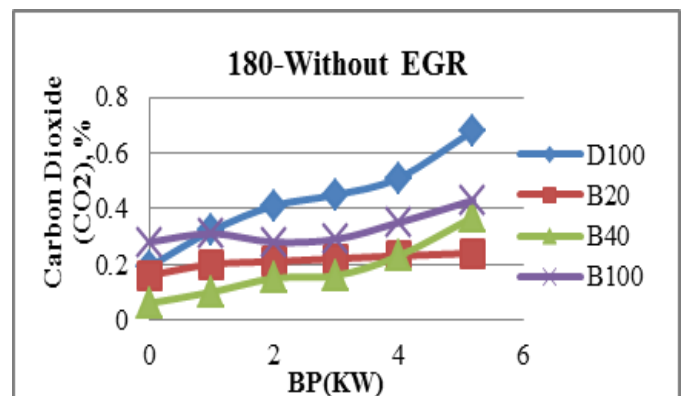

Fig: 19 Variation of carbon monoxide with brake power for pressure 180 bar and 200 bars with EGR at 10%.

Fig.19 shows comparison of CO with brake power for pressure 180 bar and 200 bars with EGR at 10% different blends of pongamia oil and diesel. It is observed that the NOx emissions increased with increase in load and increase in nozzle opening pressures. The NOx emissions for diesel in 180 bar and 200 bars are 42 ppm and 25 ppm respectively at full load. The increase in NOx emission may be due to higher injection pressure and more oxygen present in the biodiesel, resulting in increased peak combustion temperature. It is observed that the lower NOx emissions are 15ppm obtained in 180 bars with 20% pongamia biodiesel compared with the 200bars pressure. With increase in EGR level at 10% NOx level was reduced. Also reductions in brake thermal efficiency were observed.



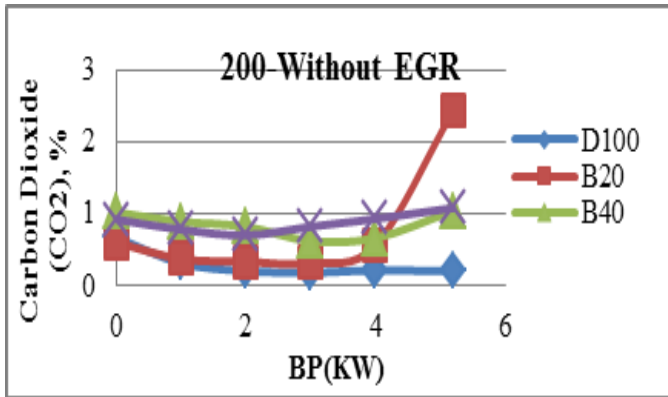

Fig: 20 Variation of carbon dioxide with brake power for pressure 180 bar and 200 bars without EGR.

Fig.20 shows comparison of CO₂ with brake power for pressure 180 bar and 200 bars without EGR different blends of pongamia oil and diesel. The CO₂ emission for diesel is higher than that of the all the blends in 180 bars and lower in 200 bars pressure. It can be observed from the figure that the CO₂ emission in percentage decreases with increasing brake power. The maximum CO₂ of pure biodiesel is 0.42% and 0.3% against 0.69% and 1.2% of the diesel in 180 bars and 200 bars pressure without EGR that of diesel engine. This may be due to complete combustion of the fuel. The minimum CO₂ emission B20 and B40 occurs at 0.3% and 1% load respectively, because the excess oxygen present in the pongamia biodiesel is helpful for better combustion. The B40 blend gives lower emission with respect to other blends.

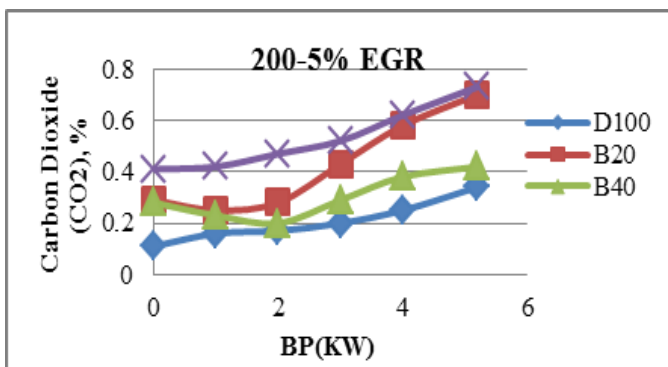
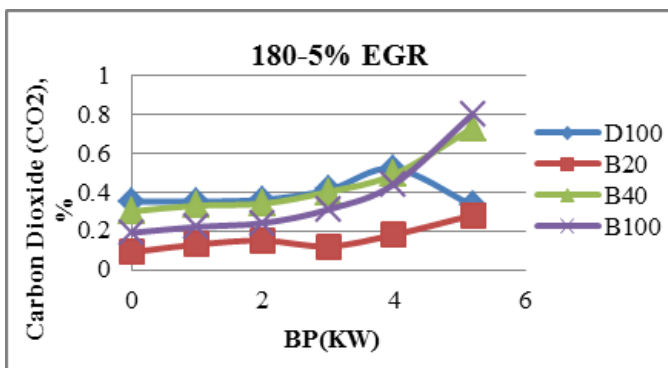

Fig: 21 Variation of carbon dioxide with brake power for pressure 180 bar and 200 bars with EGR at 5%.

Fig.21 shows comparison of CO₂ with brake power for pressure 180bar and 200bars with EGR at 5% different blends of pongamia oil and diesel. The amount of CO₂ emission was lower in case of biodiesel blended fuels and biodiesel than diesel because of the fact that biodiesel contains oxygen molecules. This may lead to complete combustion and reduction of CO₂ emission in biodiesel fuelled engine. From figure.21, B20, B40, B100 and B0 the percentage of CO₂ in the exhaust gas is 0.24%, 0.4%, 0.7% and 0.75% respectively in both graphs, At 5% EGR for biodiesel a favorable reduction in CO₂ emission can be seen at all loads. In lean mixture condition engine emits less amount of carbon dioxide.

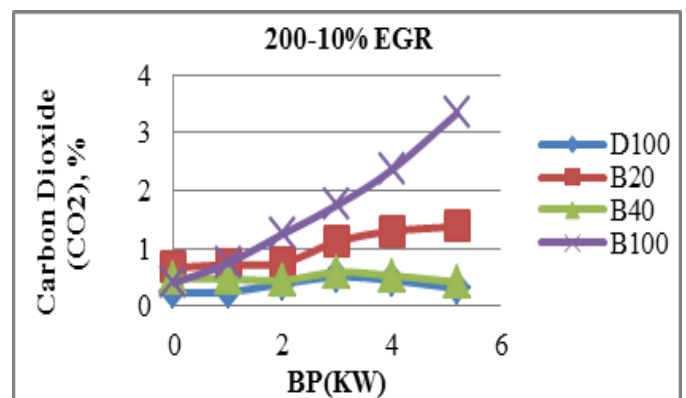
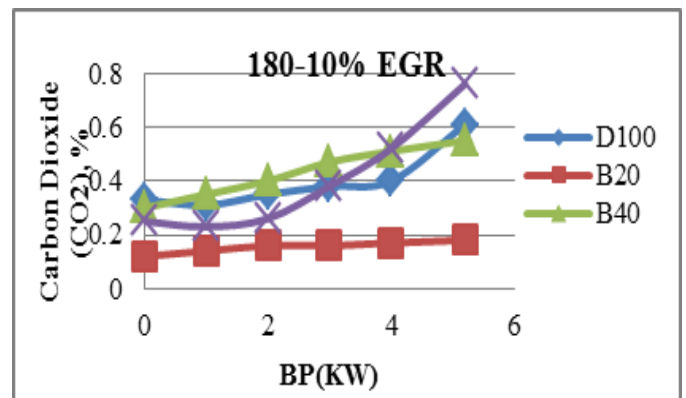

Fig: 22 Variation of carbon dioxide with brake power for pressure 180 bar and 200 bars with EGR at 10%.

Fig.22 shows comparison of CO₂ with brake power for pressure 180 bar and 200 bars with EGR at 10% different blends of pongamia oil and diesel. The variation of CO₂ produced at different engine brake power with EGR at 10% is shown in figure.22 For different blends of pongamia biodiesel increase initially and then decreases. B20 is less CO₂ emission in 180 bars and B40 is less CO₂ emission in 200 bars with EGR at 10% and all the blends higher than that of the diesel. In the case of 10% level EGR CO₂ emission was 0.85 (% by volume) for diesel and 0.90(% by volume) for biodiesel at full load. This increase in CO₂ emission with EGR might be due to oxygen deficient operation.

4.3 Combustion Characteristics

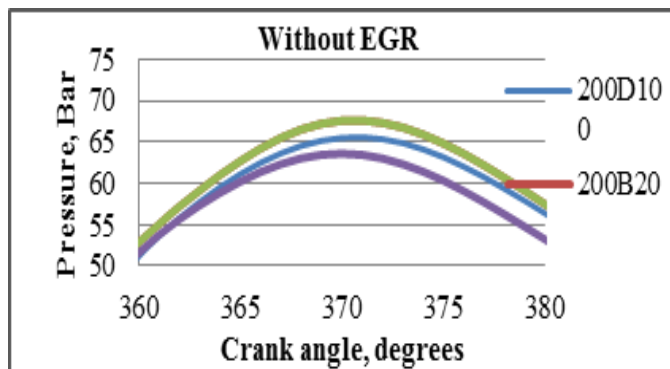
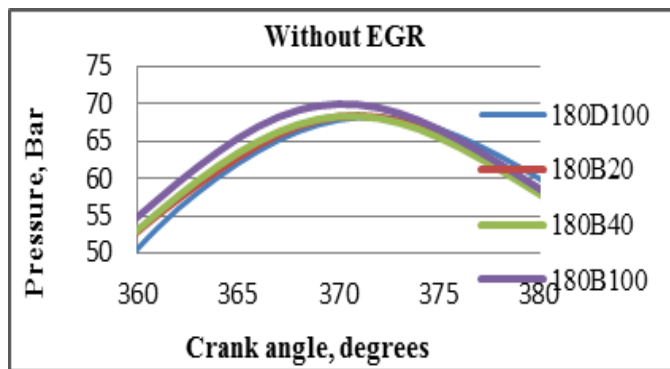

Fig: 23 Variation of cylinder pressure with brake power for pressure 180 bar and 200 bars without EGR.

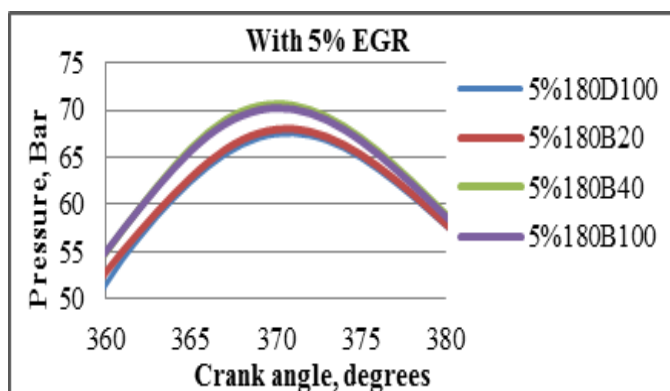
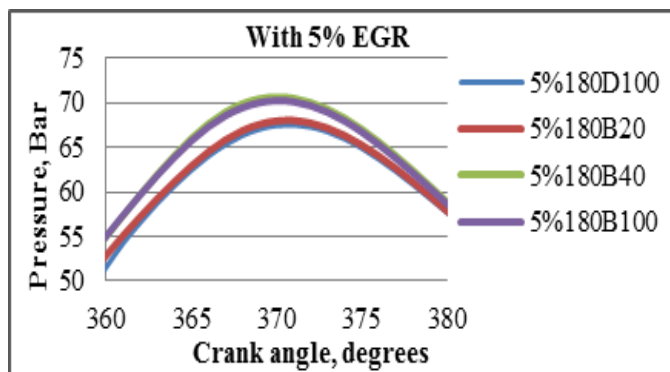

Fig: 24 Variation of cylinder pressure with brake power for pressure 180bar and 200bars with EGR at 5%.

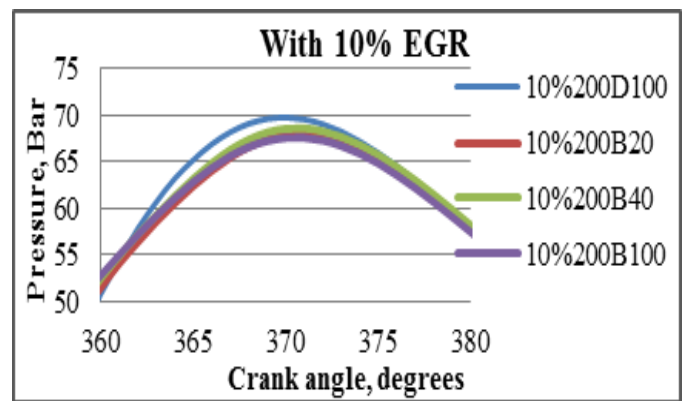
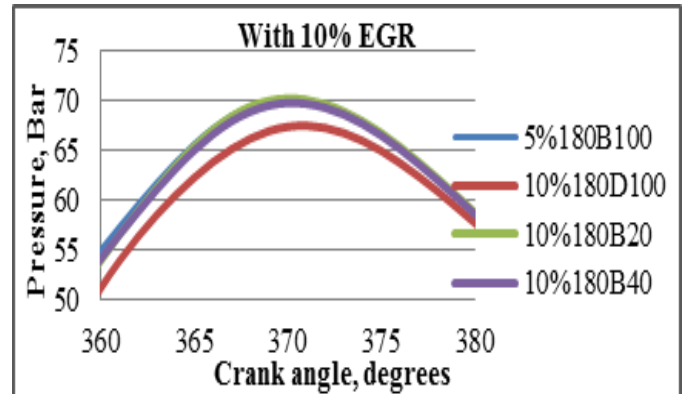

Fig: 25 Variation of cylinder pressure with brake power for pressure 180 bar and 200 bars with EGR at 10%.

The variation of cylinder pressure with respect to crank angle for diesel and different blends of pongamia biodiesel is as shown in figures 23 to 25. From the figures it is observed that the peak pressures variation are less because the properties such as calorific value, viscosity, and density are brought closer to diesel.

Cylinder pressure at full load with 180 bars and 200 bars pressure and without EGR condition was found to be comparable for diesel and pongamia biodiesel. Peak pressure was found to be 67 bars and 66 bars for diesel and 70 bars and 63 bars for biodiesel of 180 bars and 200 bars respectively. This is due to good mixture formation for biodiesel at higher loads where temperatures are high. At full load values of diesel with 5% EGR with 180 and 200 bars were 66, 70 bars for diesel and 70, 60 bars for biodiesel. At full load values of diesel with 10% EGR with 180 bar and 200 bars were 69 and 70 bars for diesel respectively whereas it was 69 and 70 bars for biodiesel. This is because the EGR serves as a heat absorbing agent, which reduces the cylinder charge temperature in the combustion chamber during the combustion process. Among the fuels tested B40 is found to have lesser ignition delay due to which there is an increase in the duration of premixed combustion phase. Hence peak pressure is higher for B40. Higher peak pressures are due to the oxygen present in the biodiesel which accelerates combustion. The peak pressure for B40 is 70.35 and 70.8 bars at injection pressure of 180 and 200 bars. Whereas the

peak pressure for diesel at injection pressure 200 bars is 70.98 bars. This indicates that peak pressure with B40 varies with change in injection pressure and it is comparable with diesel.

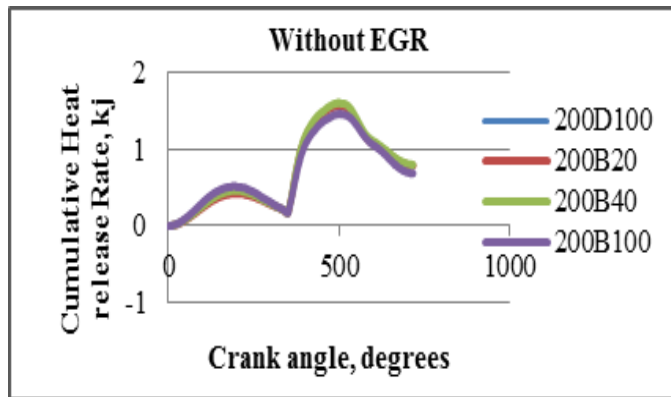

Fig: 26 Variation of cumulative heat release rate with brake power for pressure 180 bar and 200 bars without EGR.

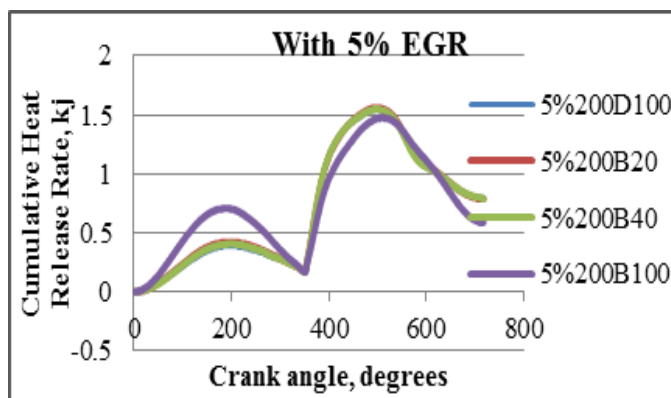
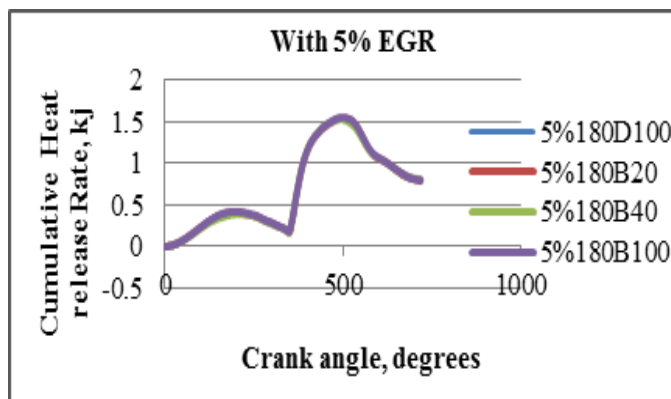

Fig: 27 Variation of cumulative heat release rate with brake power for pressure 180 bar and 200 bars with EGR at 5%.

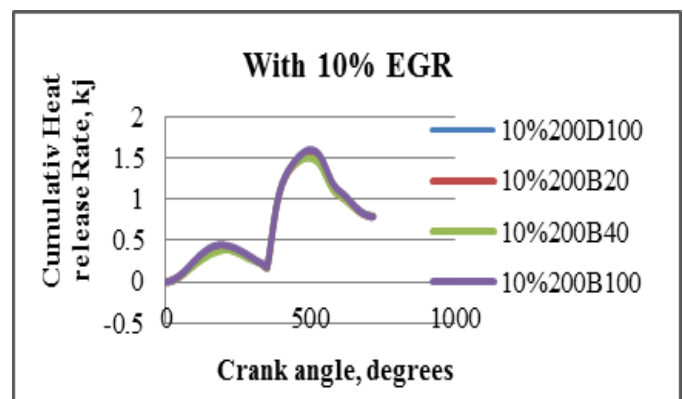
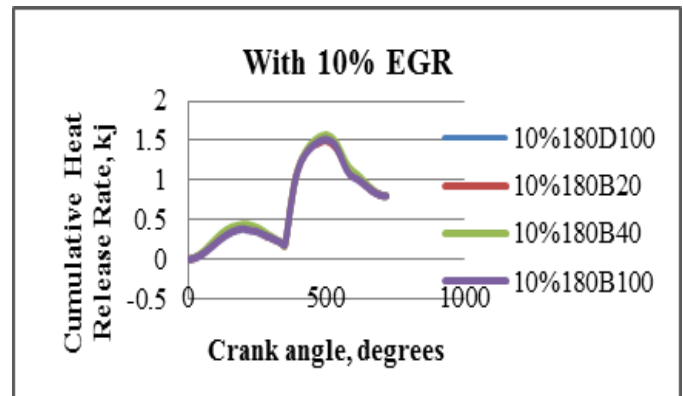

Fig: 28 Variation of cumulative heat release rate with brake power for pressure 180 bar and 200 bars with EGR at 10%.

The variation of Cumulative Heat Release Rate with respect to crank angle for diesel and different blends of pongamia biodiesel is as shown in figures 26 to 28 it was observed from the graph that there is an increase in the ignition delay for the blends. Though the start of injection is consistent for all blends and diesel the start of Combustion is delayed when compared to diesel. It is observed that the cumulative heat release rate curves of the diesel, pongamia biodiesel and their blends show similar patterns. From figure 26 to 4.28, Peak cumulative heat release rate was found to be 1.5 kJ bars for diesel and pure biodiesel and its blends of 180 bars without EGR, B40 is higher cumulative heat release rate was found to be 1.6 kJ in 200 bars without EGR respectively. At full load values of diesel with 5% and 10% EGR were 1.5 and 1.57 kJ respectively whereas it was 1.49 and 1.45 kJ for bio diesel w.r.t. 180 and 200 bars. This is because the EGR serves as a heat absorbing agent, which reduces the cylinder charge temperature in the combustion chamber during the combustion process

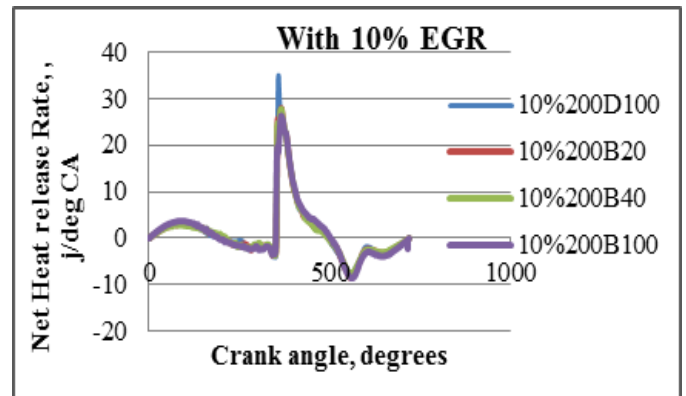
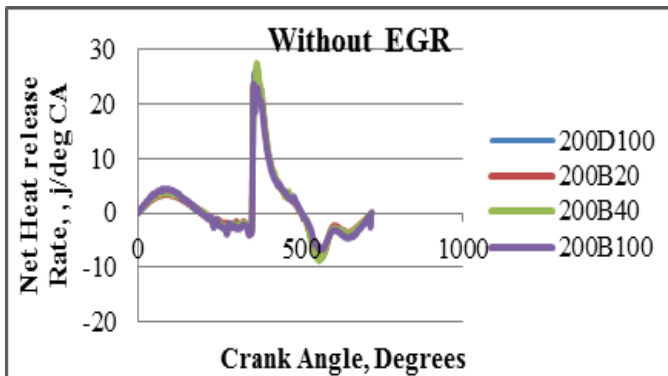
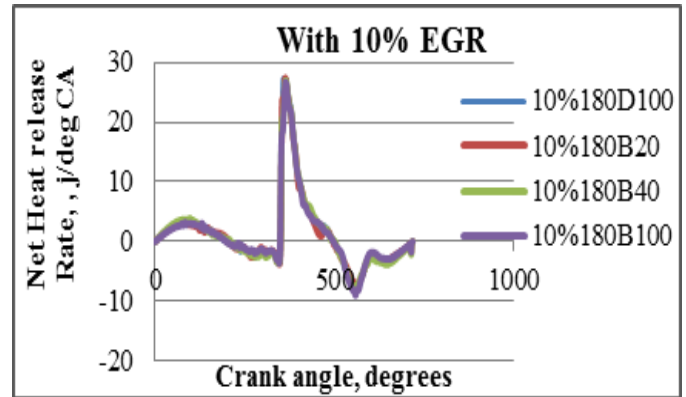
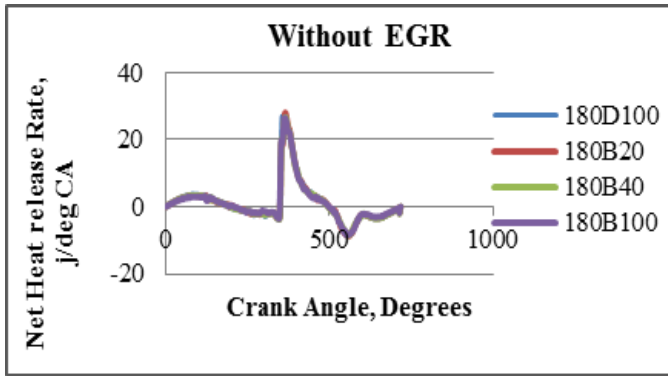

FIG: 29 Variation of cumulative heat release rate with brake power for pressure 180 bar and 200 bars without EGR.

Fig: 31 Variation of cumulative heat release rate with brake power for pressure 180 bar and 200bars with EGR at 10%.

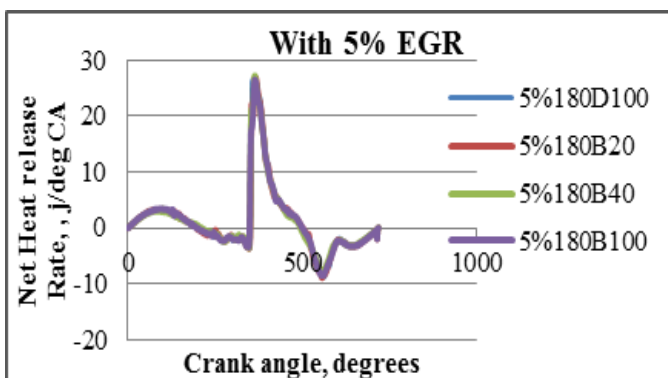
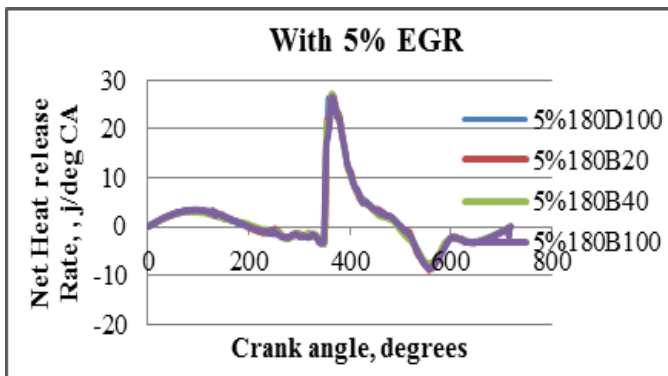

Fig: 30 Variation of cumulative heat release rate with brake power for pressure 180 bar and 200 bars with EGR at 5%.

Figures 29 to 31 shows the variation of heat release rate with crank angle for various blends of pongamia oil as well as diesel. It was observed from the graph that there is an increase in the ignition delay for the blends. Among the fuels tested B100 is found to have higher ignition delay. It is observed that the heat release rate curves of the diesel, pongamia and their blends show similar patterns. The peak heat release rates of pongamia biodiesel and their blends are lower than that of diesel.

From figure 29 to 31 at full load condition without EGR heat release rate was 28 j/deg CA for diesel and 29 j/deg CA for biodiesel and B20 is higher in 180 bars and B40 is higher in 200 bars pressure. There is a reduction in peak heat release rate for EGR operation. Decrease in heat release rate is indicative of incomplete combustion due to presence of less oxygen content when using EGR at 5% and 10%.

5.CONCLUSIONS

Experimental investigations are carried on a single cylinder water cooled four stroke DI diesel engine at constant speed at 1500 rpm to examine the stability of pongamia oil. Investigation of method to improve performance of DI engine using pongamia biodiesel by varying parameters with different injection pressure 180 bar and 200 bars and EGR at 5% and 10%. The pongamia oil blended with B0, B20, B40

and B100 of them biodiesel performance, emission, and combustion characteristics of biodiesel oils are evaluated and compared with diesel. The conclusions are follows;

- Pongamia biodiesel can be directly used in diesel engines without any engine modifications.
- The maximum brake thermal efficiency is obtained for 200 bars with 40% pongamia biodiesel compared with the 180 bar injection pressures with EGR at 5%. This is probably due to increased combustion velocity because of higher intake charge temperature with EGR at 5%. The results indicated that the brake thermal efficiency is increased about 0.84 % for 40% pongamia oil at 200 bars compared to 180 bars injection pressure.
- SFC is low in 200 bars without EGR; its due to the fuel consumption is less compared to the 180 bar with EGR because of its high latent heat vaporization.
- The EGR level was increased HC emission also increased for biodiesel. HC emission is high in 200 bars with EGR at 5% and 10%. This was due to oxygen content in biodiesel compensating for oxygen deficiency and facilitating complete combustion.
- The nitrogen oxide emission (NO_x) was increased for 40% pongamia biodiesel without EGR with 180 bar injection pressure. By using EGR at 5% and 10% the NO_x was reduced in both diesel and biodiesel. Increased EGR level NO_x value gets reduced, thus it decreases the temperature rise for the same heat release in the combustion chamber results in lower NO_x emission with EGR.
- Properties of 40% of biodiesel are very close to the diesel compared to other blends.
- Hence, it is concluded that pongamia biodiesel B40 with 180 bars with 5% EGR can be used as, alternate fuel for DI diesel engine without any major modification.

REFERENCES:

- [1] Study paper on the oil crises.
- [2] N. Stalin and H. J. Prabhu, "Performance test of IC engine using Karanja Biodiesel blending with diesel". OCT-2017
- [3] An overview of Biodiesel and petroleum Diesel Lifestyles, May 1998, Sheehan, et al. NRE
- [4] WWW.Energyrevolution,Co.Za/
Biodiesel/advantages
- [5] WWW.Energyrevolution.Co.Za/Biodiesel/disadvantages
- [6] Shruti H Heroor, S. D. Rahul Bharadwaj, production of bio-fuel from pongamia and its performance on CI- engine. ISSN 2231-1319, Volume 4, number 6 (2013), pp.
- [7] K. Veeraghavulu, Sudhakar Uppalapati, Nirmala K, "performance test on IC engine using pongamia oil" (IJJET), Volume 6 Issue 4 April 2016.
- [8] M.C.Navindagi, Maheswar Dutta, experiment conducted on comparative performance analysis of castor and cottonseed oil as alternative fuel in CI engine. (NCRAME – 2011), 2-3 December, 2011.