

Design and Development of Hydraulic Solar Tracking System

Akshay Kandave¹, Shubham Kadam², Amol Shinde³ SaurabhSagalgile⁴

^{1,2,3,4}Students, Alard College of Engineering, Pune

Abstract: Nowadays solar power considered as reliable energy source for power generation and for many other applications. The challenge is to fetch maximum amount of energy from solar radiations in which sun is continuously changing its position in sky. There are many problems associated with conventional solar panel because they are fixed in one direction. The positions of the sun keeps on changing every day, along with the sun, solar panel have to move in same direction. The other system also used for solar tracking but they consumes most of the energy produced by solar panels for tracking, which effects the efficiency of solar panel.

INTRODUCTION

The basic problem associated with conversion of solar energy into useful form is that the solar modules used are stationary so during the morning and evening hours the sun rays falls at an angle upon the module. This decreases the efficiency of system. Thus the conversion efficiency of solar panel to charge the batteries in solar farm is not up to the mark.

LAYOUT OF SYSTEM :-

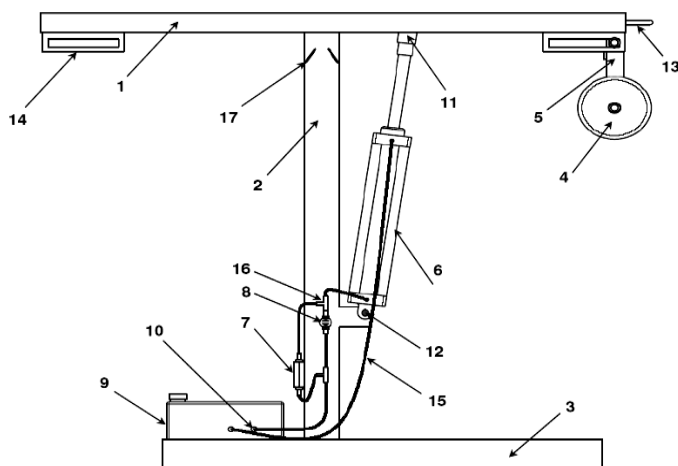

- | | | | |
|---------------|---------------------------|----------------------|-----------------------------|
| 1) Panel seat | 5) Weight holder | 9) Reservoir | 13) Handle |
| 2) Column | 6) Double acting cylinder | 10) Filter | 14) Counter weight platform |
| 3) Base | 7) Check valve | 11) Rod end mounting | 15) Connecting hose |
| 4) Weight | 8) Flow control valve | 12) Piston end hinge | 16) T-Connector |
| | | | 17) Stopper |

Tracking mechanism:

The mechanism selected for tracking system is based on lever principle. The type of lever used manipulate the required load is Second type lever. Basically, a lever is rod or bar capable of turning about a fixed point called fulcrum. It is used as a machine to lift / transmit a load by the application of small effort. The ratio of load lifted to the effort applied is called mechanical advantage. A lever may be Straight or curved and the forces applied on the lever (or by the lever) may be parallel or inclined to one another.

Application of Levers in Engineering Practice:

The load (W) and the effort (P) may be applied to the lever in three different ways. The Fulcrum is denoted by F and direction of reaction is indicated by an arrow mark.

1. First type/First class lever:

In the first type of levers, the fulcrum is in between load and effort. These levers are commonly used in railway signaling, rocker arms, hand pumps, foot levers etc. As shown in figure.

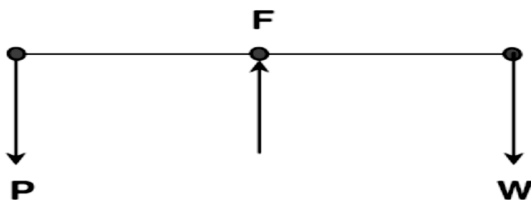

2. Second type/Second class lever:

In this type, the load is in between the fulcrum and effort. The application of such type of lever is found in levers of loaded safety valves. As shown in figure.

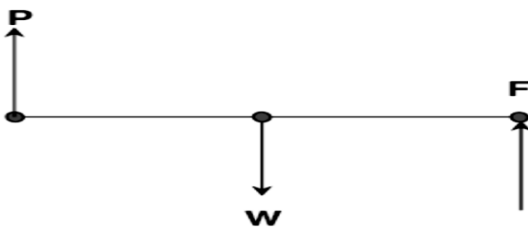

3. Third type/Third class levers:

In this type of levers, the effort is in between the fulcrum and load. The use of such type of levers is not recommended in engineering practice. However a pair of tongs, the treadle of sewing machine is the examples of this type of lever. As shown in figure.

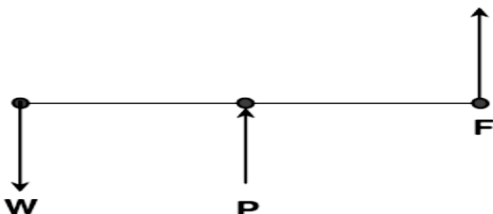

Working procedure:

Working procedure of the designed tracking system is explained by the hydraulic circuit diagram and by the schematic diagrams. Each duty cycle of the system contains two steps.

a. Tracking:

As the tracking weight acts on the piston through piston rod, it pushes the oil out of the cylinder and the oil flows towards reservoir. While, due to the restricted cross sectional area at flow control valve the piston moves with the velocity equal to calculated tracking velocity. During this action the check valve remains closed, hence oil is allowed to flow only through flow control valve. At the rod end of the cylinder, the oil is sucked into cylinder due to the vacuum pressure created by the applied weight. As shown in fig. 4.8.

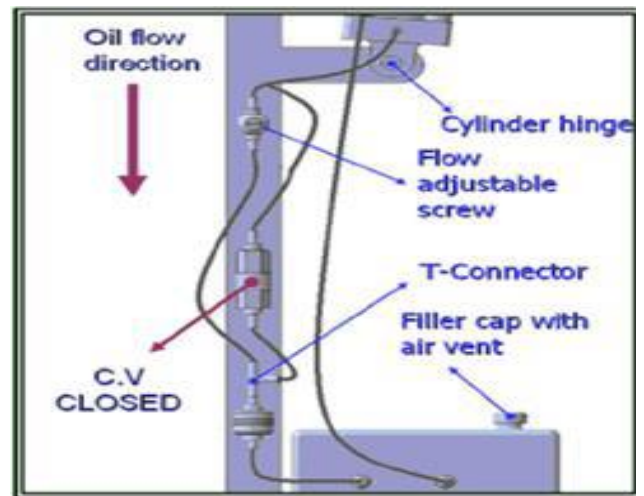

b. Return:

As the tracking time finishes, the panel seat has to be rotated by applying the torque, manually, to bring back into initial position. The vacuum pressure is created at piston end chamber and oil from reservoir rushes towards cylinder. As soon as the system pressure exceeds the cracking pressure of check valve, check valve opens and allowing full flow of oil from it, reducing the time required for repositioning operation.

The flow control valve also allows the oil to flow from it, increasing rate of flow and reduced panel repositioning time. At rod end of cylinder the piston forces the oil. The oil pressure increases and oil flows out of the cylinder. Oil returns to reservoir through a filter placed in the return line. As shown in fig. 4.9.

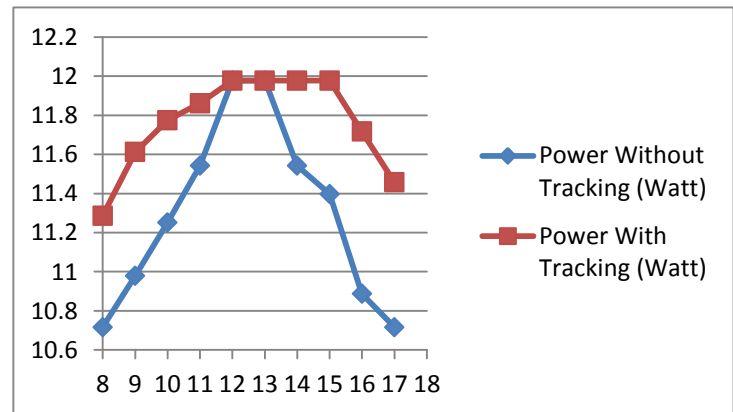
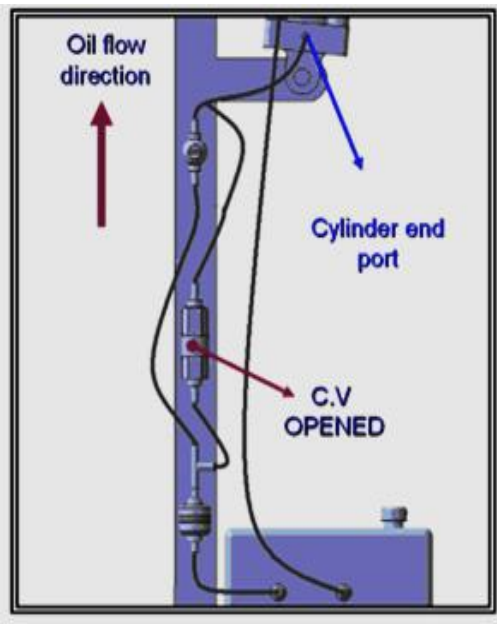

Advantages:

- a) Hydraulic solar tracker is easy to design and manufacture compare to other tracker system.
- b) Increased reliability and robustness of hydraulic control system compared with other solar tracker
- c) Hydraulic solar trackers generate more energy than other tracking system like electric solartracker.

Disadvantages:

- a) Structurally less rigid then permanent mounts and hence can be vulnerable to storm damage.
- b) More chances to leakage of hydraulic oil.
- c) Required manual power to pump the oil in cylinder.



Mechanical Solar Tracking System

CONCLUSION:

This is the first attempt made towards utilizing the gravitational energy as a driving force for solar tracking systems and also in providing a suitable tracking system for the remote places. In view of increasing demand for the electrical power, this tracking system can contribute a little (around 87.6 kW-hr per year) in the fulfillment this demand.

REFERENCES:

- 1))Saad D. Odehet.all-MulawehUniversity of South Australia- Design and development of an educational solar tracking parabolic trough collector Adelaide, Australia Indiana University-Purdue University Fort Wayne, Fort Wayne, Indiana, United States of America.
- 2) Shahidul I. Khan et.all-Department of Electrical And Electronics Engineering And Department of Mechanical Engineering,Bangladesh University of Engineering And Technology,Dhaka,Bangladesh.pp 98-102,Published December 2013.
- 3) SowbiyaMuneeret.all-Department of Horticulture, College of Agricultural Life Sciences, Chonnam National University, 300 Young Bong-Dong Buk-Gu, Gwangju, 500-757, Published 17 March 2014.
- 4) Zhaoqing Wang et.all-School of Life Sciences, Shanxi Normal University, Linfen, China And Biotechnology Research Centre And Shanxi Academy of Agricultural Sciences, Taiyuan, China,pp 38-42.Published online August 10, 2015.
- 5) MahirDurshanet.all-the Department of Electrical & Electronic Engineering, Faculty of Technology,Gazi University, Ankara, Turkey.161-164.Published April 2012.
- 6) Liu Xiaoying et.all,-the Nanjing Agriculture University, Nanjing Jiangsu 210095,China.And Institute of Biological Science,Nagoya University, Nagoya 464-8601,Japan.pp.6169-6177,March 2012.
- 7) Prof. Kusekar S.Ket.all-Professor, Department Of Mechanical Engineering
A G. Patil Institute of Technology,Solapur, Maharashtra- India, Volume 2, Issue 8, PP 2856-2881, April 2015.
- 8) Rohit Agarwal-Central Maintenance Department, Essar Steel (I) Ltd, India, PP 24-27, 2014.
- 9) Ligu Tian et.all-School of Electrical engineering and Automation, Tianjin, 300072,China, Volume 7 No 9, PP 367-374,2014.