

Comparative Harmonic Analysis of a 3-Phase Bridge Type Inverter Operating at different Conduction Mode using RL-Load

Ankit .S. Makwana¹

¹Student,Electrical Engineering Department, Sardar Vallabhbhai Patel Institute of Technology,Vasad,Gujarat,India

Abstract – This paper presents the harmonic analysis on PSCAD model of a 3-Phase Bridge Type Voltage Source Inverter operating at 120°, 150° and 180° conduction mode using RL-Load. A detailed comparative harmonic analysis is carried out explaining the reduction in the Total Harmonic Distortion (THD) when Voltage Source Inverter is operated at different conduction mode and also explains how input voltage waveform get distorted due to injection of input harmonic current. It is concluded from simulation model results that 150° conduction mode of operation has less Total Harmonic Distortion as compared to other mode of operations but minimum input voltage distortion is created when VSI is operated at 180° conduction mode.

Key Words: 3-Phase Inverter, 120° Conduction mode, 150° Conduction mode, 180° Conduction mode, Total Harmonics Distortion,

1. INTRODUCTION

Generating electricity from renewable natural resources like wind and sun etc. are commonly used in order to fulfil the increased power demand. Harnessing electrical energy from natural resources is not easy and cannot be used directly to power the load. To do so, power electronic converters are used. Thus it becomes important to design these converters optimally in order to provide high efficiency and reliability of the system. Inverters has wide range of applications, from small switching power supplies, to large electric power utility using HVDC system to transmit bulk power at a high voltage to a far distance. A power electronics inverter is widely used as D.C to A.C converter in VFD at desired frequency and voltage.

There are two types of power topologies in inverter, namely Voltage Source Inverter and Current Source Inverter which is further classified as single phase inverter and three phase inverter. Three phase inverter can be operated in three different conduction modes i.e. 180°, 120° and 150° conduction mode. Use of inverters in power system creates harmonics which are harmful to the system. So to mitigate harmonics from the system, improved controlling techniques and PWM technique are used. The variable output voltage and reduction in harmonics can be obtained operating at different conduction modes of 3 phase inverter. From this discussion comparison topics are achieved. This paper focuses on of 3 phase bridge type voltage source inverter of a

VFD to provide comparative analysis of harmonic reduction operating at different conduction mode by using RL Load.

2. 3-Phase Voltage Source Inverter

In order to provide variable frequency power, 3- phase VSI are more commonly used than single phase VSI. A three-phase inverter converts a Direct Current input into a 3-phase Alternating Current output. Basic 3-phase VSI is a six step bridge inverter. Minimum six switches are used. In this topology a proper firing sequence is define. For a complete cycle of 360° switches would be fired at a regular interval of 60°. Fig-1 elicits the power circuit diagram of 3-phase VSI using six IGBT and six diode. The switches I1 and I4, the switches I2 and I5 and switches I3 and I6 complement each other. It is nothing but three single phase inverters put across the same DC source. Large capacitor is connected to make the DC voltage constant. A star connected 3- phase RL load is connected having R = 30 Ohm and L = 10 mH respectively. There are 3 possible ways of firing the IGBT i.e. 180°, 120° and 150°.

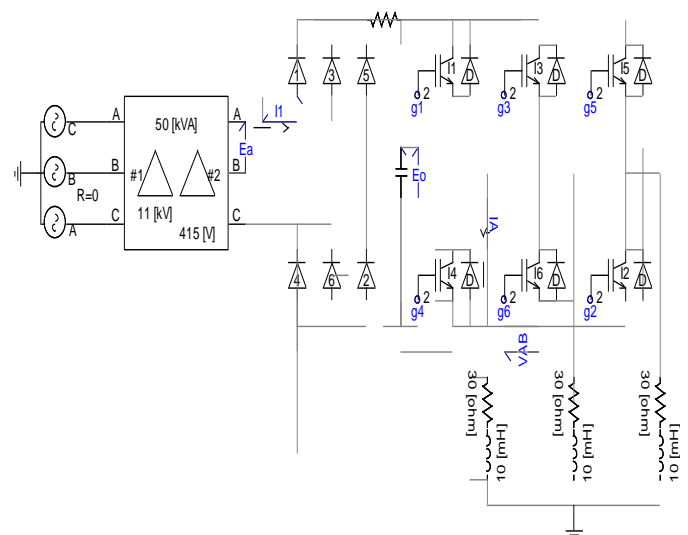

Fig-1 Power circuit diagram of 3-phase VSI

3. 180° CONDUCTION MODE

In this conduction mode each switch conducts for 180°. At any instant of time, only three switches will conduct simultaneously, two of which are from one group (upper three or lower three) and remaining one from the other group. After every 60°, one of the conducting switches is turned off and some other switch will start conducting. In

this conduction mode upper switch of the leg turns off and at the same time lower switch of the same leg will be turned on. Output line to line voltage (V_{AB}) is Quasi square wave and Output phase to ground voltage (V_{AN}) is a six step wave with $E_o/3$ & $E_o(2/3)$ height. Operation of switches in 180° conduction modes is shown in Table-1 and Fig- 2 show the simulation of gating pulse for all six switches.

| Sr.no | Interval | Device Conducting |
|-------|----------|-------------------|
| 1 | I | 5,6,1 |
| 2 | II | 6,1,2 |
| 3 | III | 1,2,3 |
| 4 | IV | 2,3,4 |
| 5 | V | 3,4,5 |
| 6 | VI | 4,5,6 |

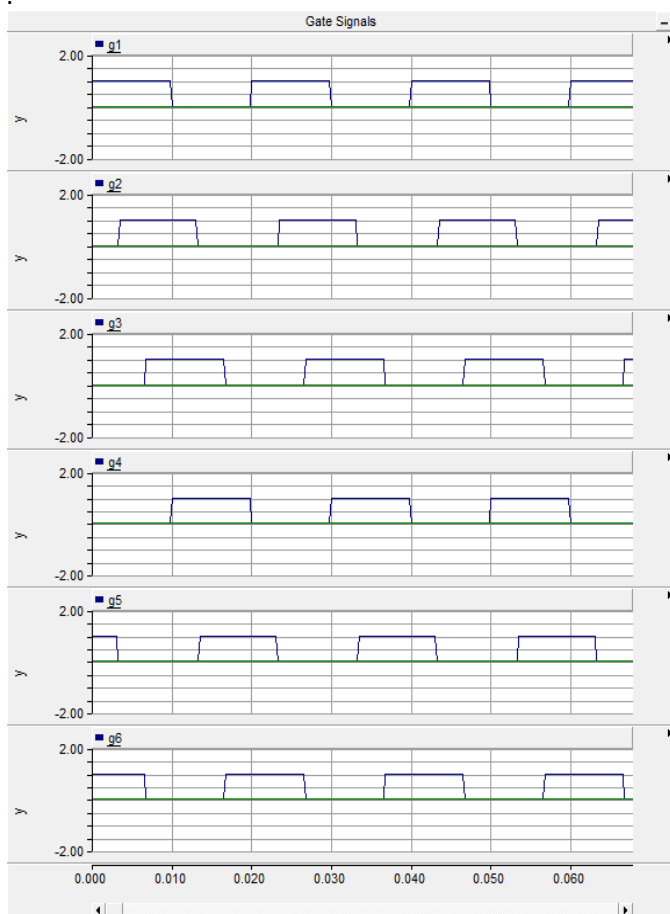

Fig-2 Gate Pulse for 180° conduction mode

The VFD is feed by 50KVA 11KV/415V step-down transformer connected in Delta-Delta fashion. The output of the DC-Link capacitor link is $E_o = 500$ V which is applied to inverter shown in Fig-3. Output of 3-phase bridge inverter at

180° mode is connected to 3-phase star RL-Load which is non-sinusoidal and contains some amount of harmonics. Load current contain harmonics which causes noise copper loss, vibration loss and pulsating torque. Fig-4, Fig-5 and Fig-6 show the Output line to line voltage (V_{AB}), Output phase to ground voltage (V_{AN}) and Load current (I_A) of the RL-Load respectively. Input line current (I_1) drawn by the VFD and Input line to line voltage (E_A) is shown Fig-7. and Fig-8. The characteristic double hump for each half cycle of AC waveform is due to conduction of input rectifier module.

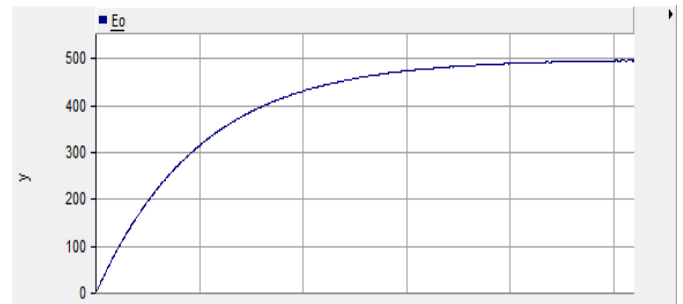

Fig-3 DC-Link Output

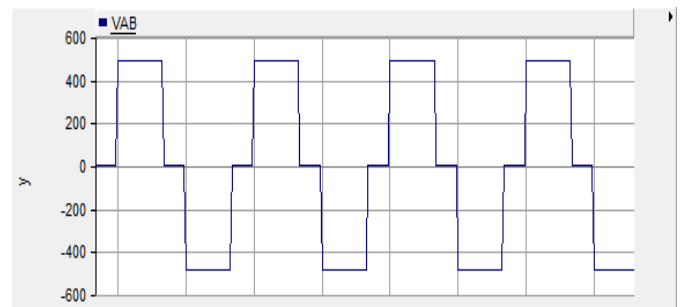

Fig-4 Output line to line voltage $V_{AB}(180^\circ$ mode)

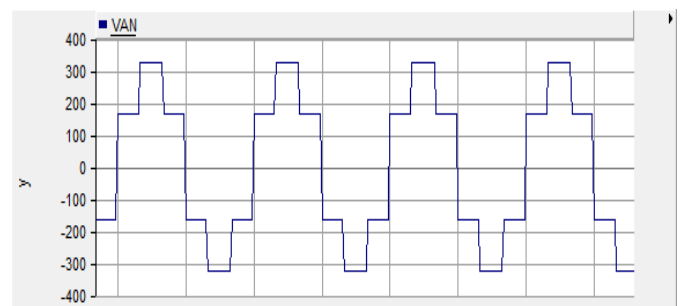

Fig-5 Output phase to ground voltage V_{AN} (180° mode)

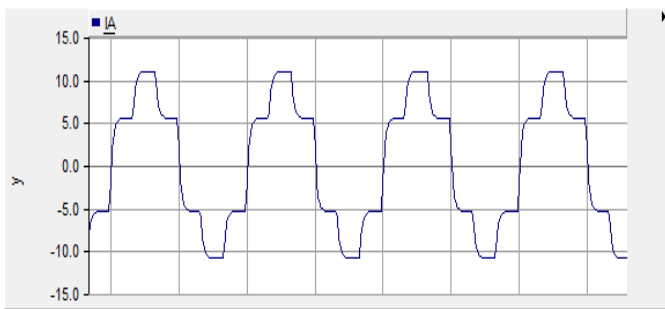

Fig-6 Load Current I_A (180° mode)

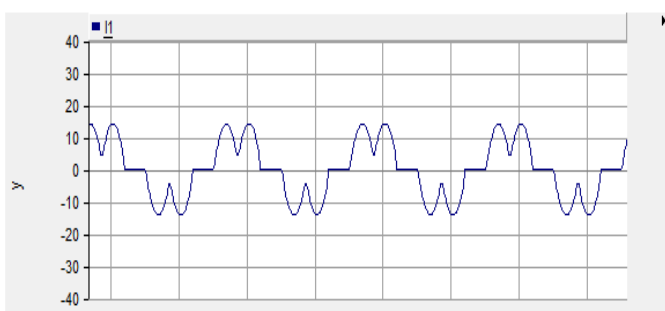

Fig-7 Input Line Current I_1 (180° mode)

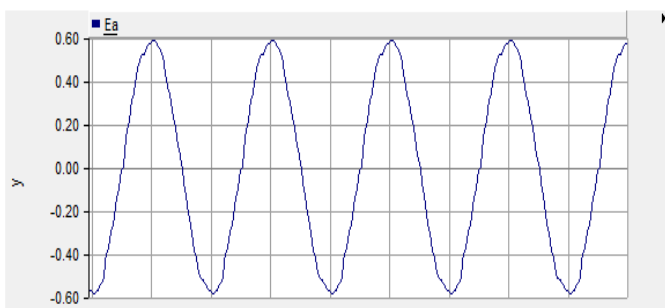

Fig-8 Input Line to Line Voltage E_A (180° mode)

4. 120° CONDUCTION MODE

In this conduction mode each switch conducts for 120° time period. At any instant of time, two switches will conduct simultaneously. After every 60°, one of the conducting switch is turned off and the next incoming switch is triggered and starts conducting. In this conduction mode there is a delay of 30° between turning on and turning off of switches of same leg. So there is no possibility of short circuit. Output voltage waveform V_{AB} is six-step wave with $E_o/2$ & E_o height and Output phase voltage V_{AN} is a Quasi square wave with $E_o/2$ height. Operation of switches in 120° conduction modes is shown in Table-2 and Fig- 9 show the simulation of gating pulse for all six switches. Fig-10, Fig-11

and Fig-12 show the Output line to line voltage (V_{AB}), Output phase to ground Voltage (V_{AN}) and Load current (I_A) of the RL-Load respectively. Input line current (I_1) drawn by the VFD and Input Line to Line Voltage E_A is shown Fig-13. And Fig-14

| Table-2 Operation table | | |
|-------------------------|----------|-------------------|
| Sr.no | Interval | Device Conducting |
| 1 | I | 6,1 |
| 2 | II | 1,2 |
| 3 | III | 2,3 |
| 4 | IV | 3,4 |
| 5 | V | 4,5 |
| 6 | VI | 5,6 |

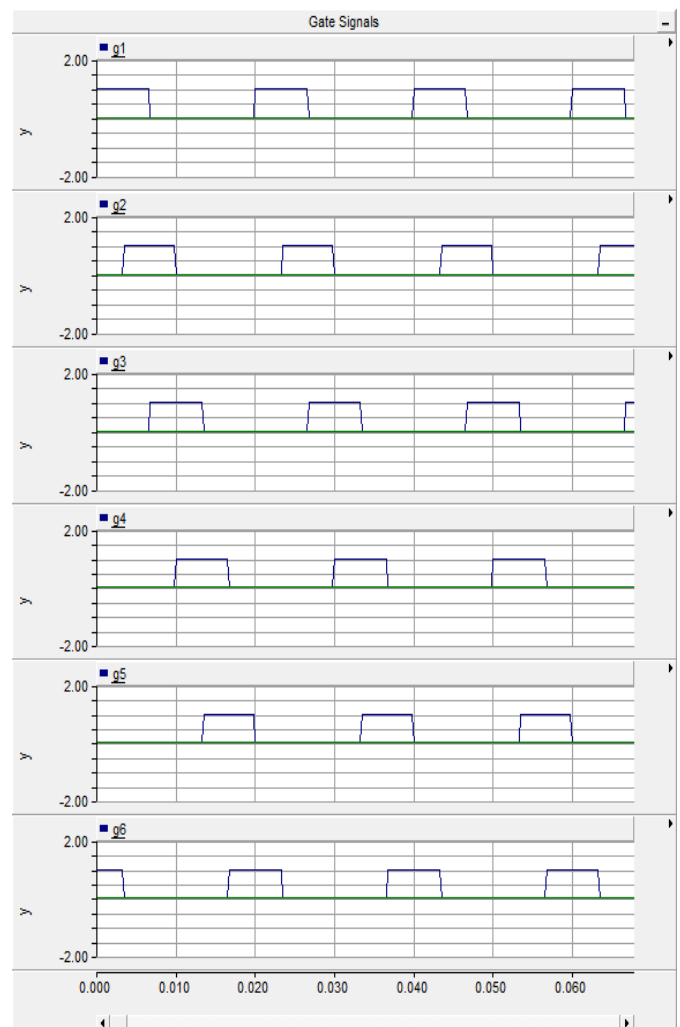

Fig-9 Gate pulse for 120° conduction mode

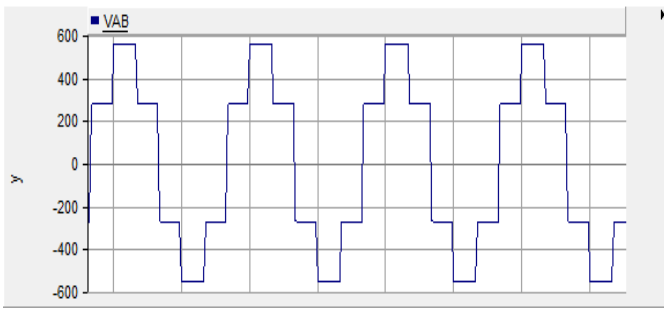

Fig-10 Output line to line voltage V_{AB} (120° mode)

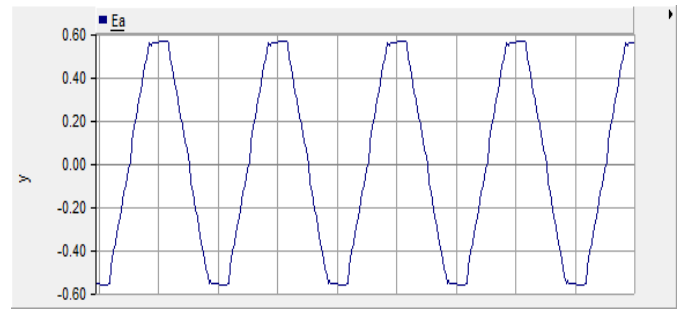

Fig-14 Input Line to Line Voltage E_A (120° mode)

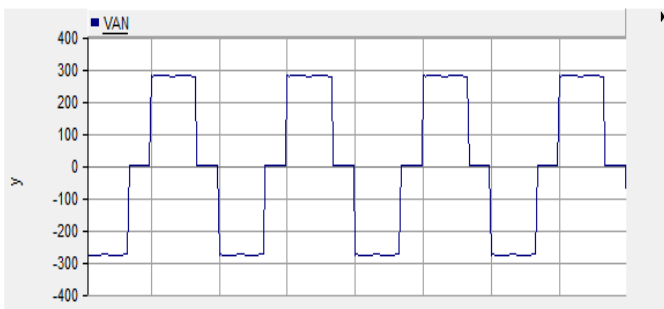

Fig-11 Output phase to ground voltage V_{AN} (120° mode)



Fig-12 Load Current I_A (120° mode)

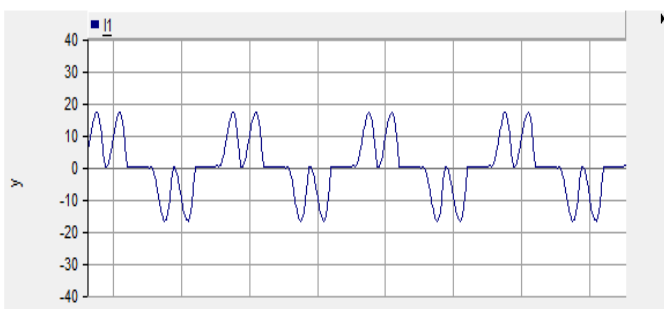

Fig-13 Input Line Current I_1 (120° mode)

5. 150° CONDUCTION MODE

For 150° conduction mode, each switch conducts for 150° of a cycle. In this mode of conduction 12 switching patterns are available, each of 30° duration. Three switch conduct in one interval, while only two transistors conduct in the next one, similar to 180° and 120° conduction modes respectively. Operation of switches in 150° conduction modes is shown in Table-3 and Fig- 15 show the simulation of gating pulse for all six switches. Fig-16, Fig-17 and Fig-18 show the Output line to line voltage (V_{AB}), Output phase to ground voltage (V_{AN}) and Load current (I_A) of the RL-Load respectively. Input line current (I_1) drawn by the VFD and Input Line to Line Voltage E_A is shown Fig-19 and Fig-20.

| Table-3 Operation table | | |
|-------------------------|----------|-------------------|
| Sr.no | Interval | Device Conducting |
| 1 | I | 5,6,1 |
| 2 | II | 6,1 |
| 3 | III | 6,1,2 |
| 4 | IV | 1,2 |
| 5 | V | 1,2,3 |
| 6 | VI | 2,3 |
| 7 | VII | 2,3,4 |
| 8 | VIII | 3,4 |
| 9 | IX | 3,4,5 |
| 10 | X | 4,5 |
| 11 | XI | 4,5,6 |
| 12 | XII | 5,6 |

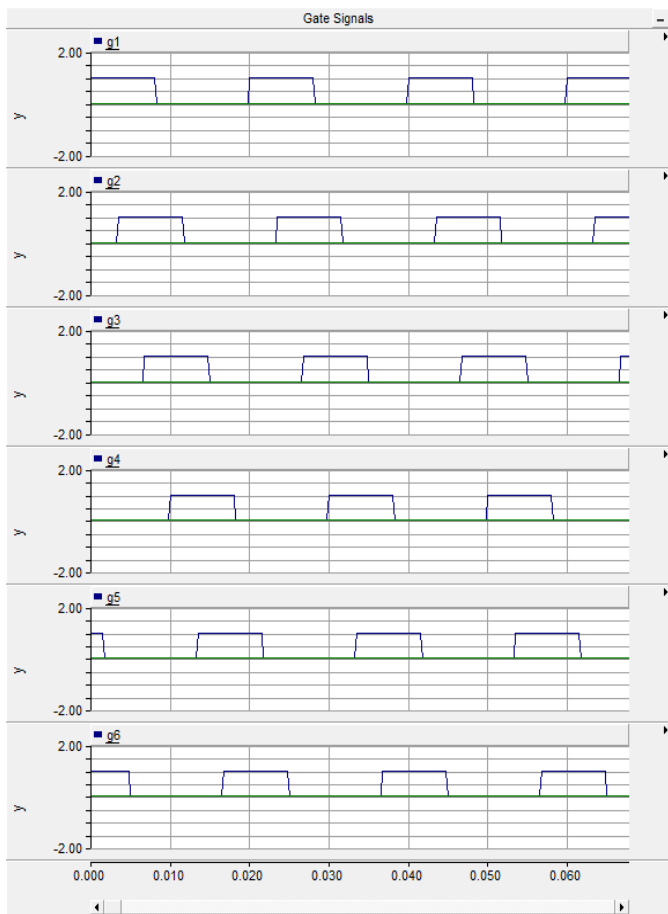

Fig-15 Gate pulse for 150° conduction mode

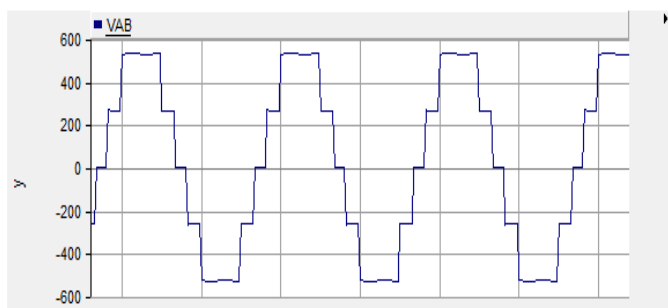

Fig-16 Output line to line voltage V_{AB} (150° mode)

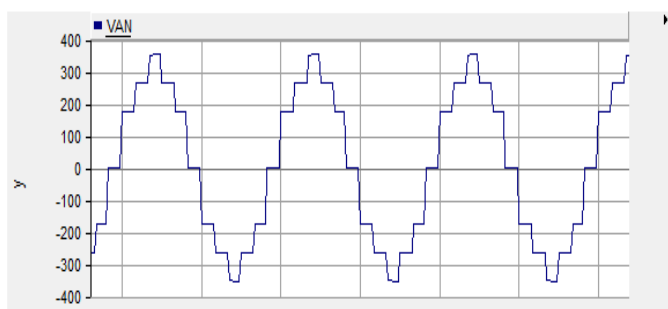

Fig-17 Output phase to ground voltage V_{AN} (150° mode)

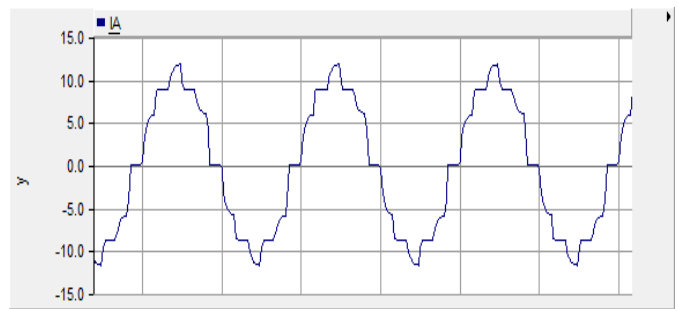

Fig-18 Load Current I_A (150° mode)

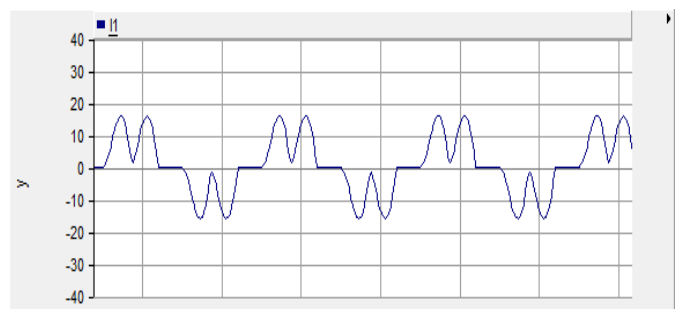

Fig-19 Input Line Current I_1 (150° mode)

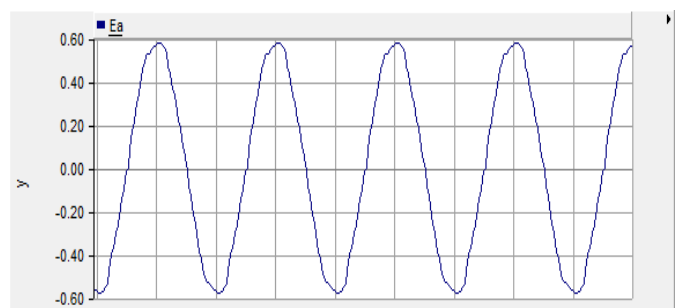

Fig-20 Input Line to Line Voltage E_A (150° mode)

6. COMPARISON OF HARMONICS ANALYSIS

In this simulation model, the harmonics at 180°, 120° and 150° Conduction modes of 3-phase Bridge Type VSI are analyzed. The comparative harmonic analysis is done for all conduction modes. The FFT analysis of the Output line to line voltage V_{AB} , Load current I_A , Input line current I_1 and Input Line to Line Voltage E_A is done. The output waveform of these modes of inverter shows that there is no DC component and very less magnitude of even harmonics. Fig-21, Fig-22 and Fig-23 shows the Output line to line voltage Total Harmonic Distortion at different conduction mode. Thus by looking at the Fig-21, Fig-22 and Fig-23 it can

be said that Output line to line voltage Total Harmonic Distortion is minimum when VSI is operated at 150° mode. Fig.24a, Fig.24b, Fig-25a, Fig.25b and Fig-26a, Fig-26b show the Load current I_A 5TH and 7TH harmonic spectrum for 180°, 120° and 150° conduction mode of VSI respectively. It can be seen that 3RD harmonic and its multiple are absent in the entire conduction mode.

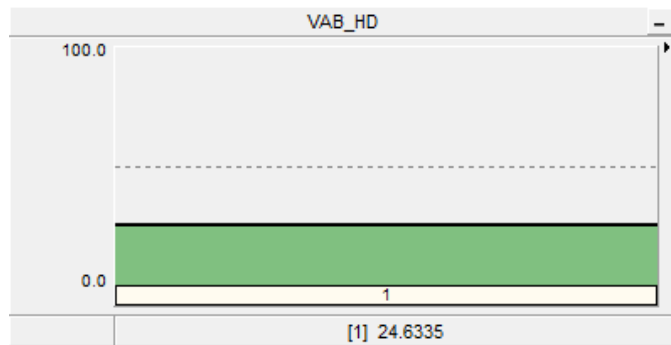

Fig-21 Output line to line voltage THD(180° mode)

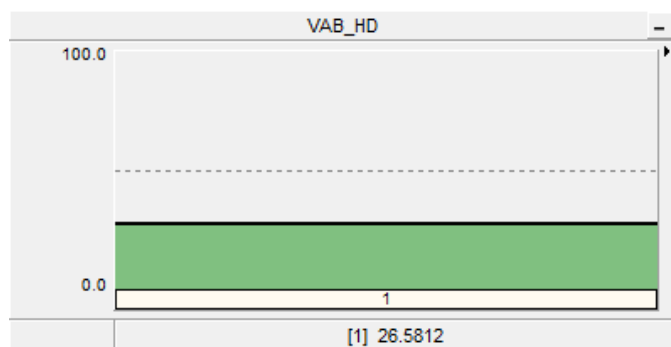

Fig-22 Output line to line voltage THD (120° mode)

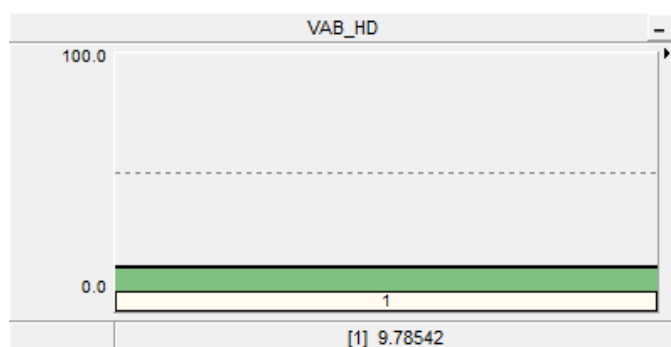

Fig-23 Output line to line voltage THD (150° mode)

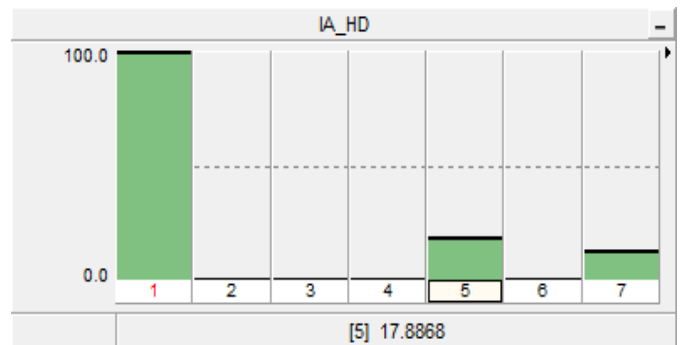

Fig-24a Load Current 5TH harmonic (180° mode)

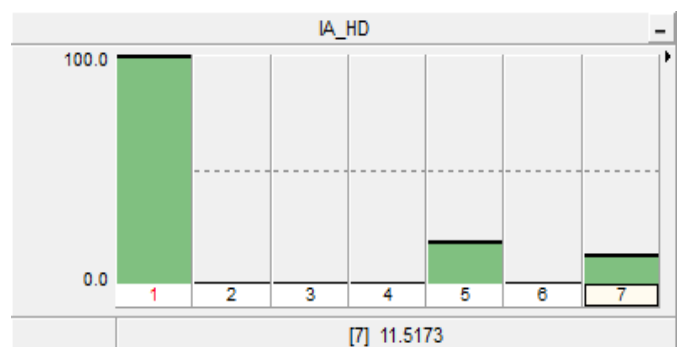

Fig-24b Load Current 7TH harmonic (180° mode)

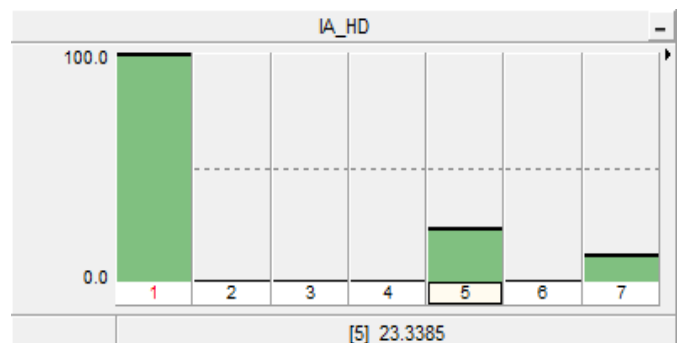

Fig-25a Load Current 5TH harmonic (120° mode)

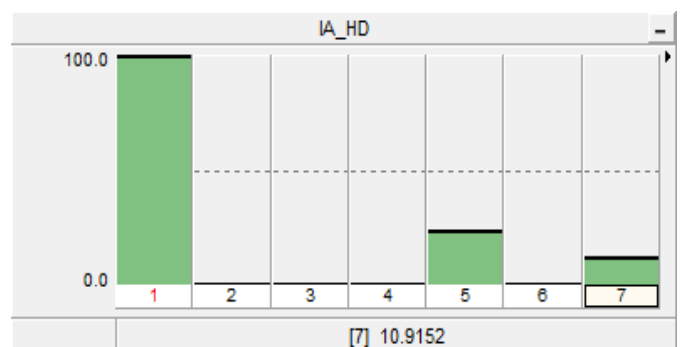

Fig-25b Load Current 7TH harmonic (120° mode)

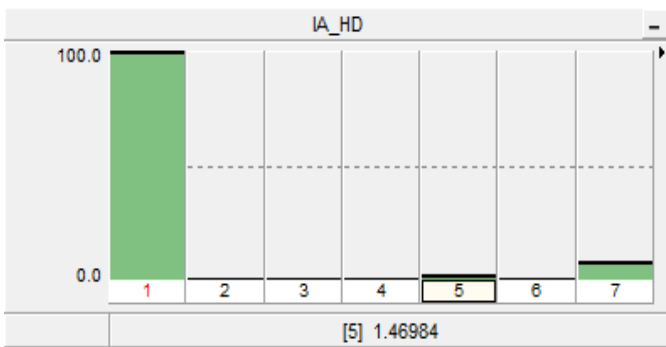

Fig-26a Load Current 5TH harmonic (150° mode)

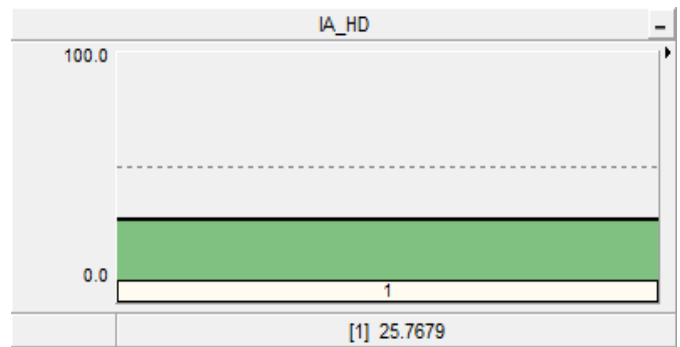

Fig-28 Load Current THD (120° mode)

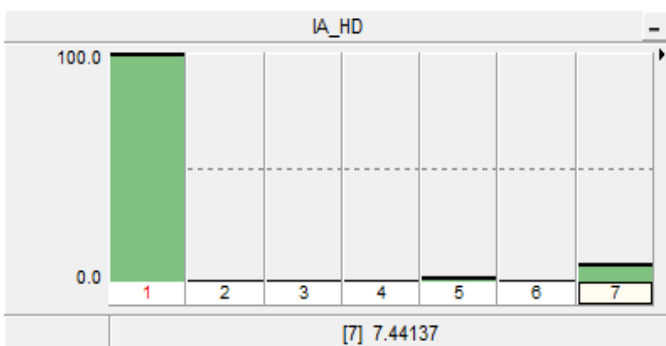

Fig-26b Load Current 7TH harmonic (150° mode)

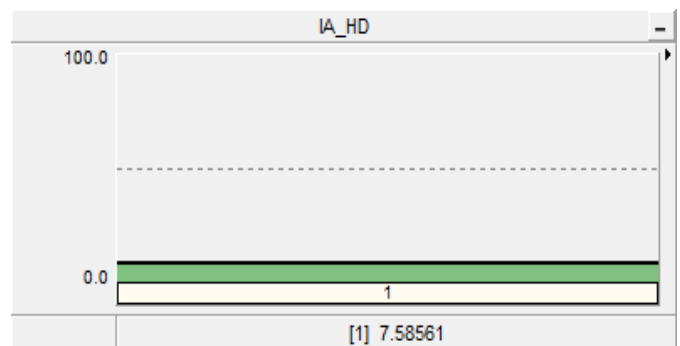

Fig-29 Load Current THD (150° mode)

Fig-27, Fig-28 and Fig-29 shows the Load Current THD with maximum lower harmonics contents as 5TH and 7TH. Thus, it can be concluded that operating 3-phase Bridge type VSI operated at 150° conduction mode can only cause 7.8% THD in load current.

Fig-30a, Fig-30b, Fig-31a, Fig-31b and Fig-32a and Fig-32b show the Input line current I_1 for different conduction mode. It can be seen that 5th and 7th harmonic are the major cause of distortion in waveform. Fig-33, Fig-34 and Fig-35 shows the Input current I_1 THD operating 3-phase VSI at 180° 120° and 150° conduction mode. And Fig-36, Fig-37 and Fig-38 shows the Input Line to Line Voltage E_A Total Harmonic Distortion caused by the injection of Input harmonic current I_1 .

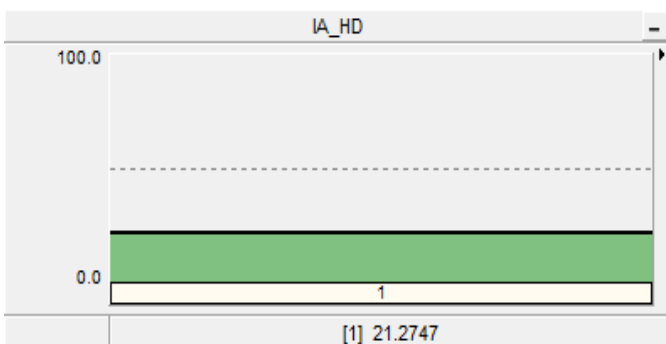

Fig-27 Load Current THD (180° mode)

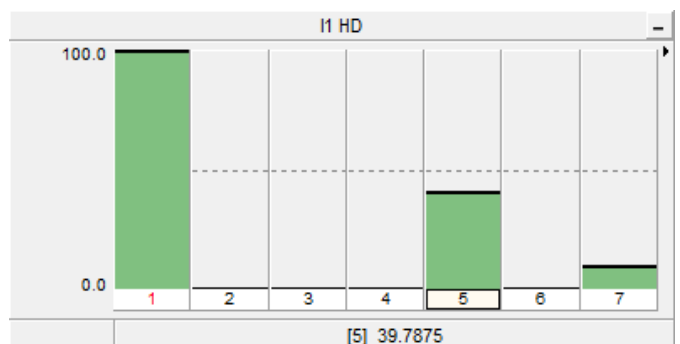

Fig-30a Input Line Current 5th harmonic (180° mode)

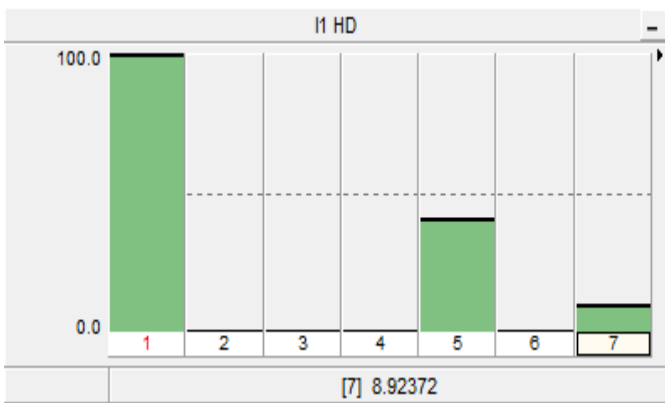

Fig-30b Input Line Current 7th harmonic (180° mode)

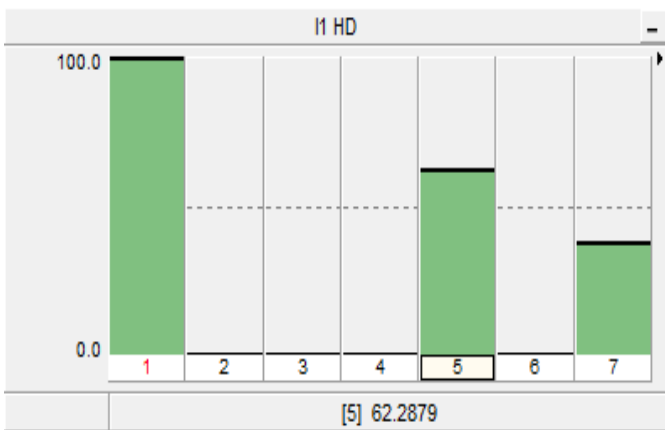

Fig-31a Input Line Current 5th harmonic (120° mode)

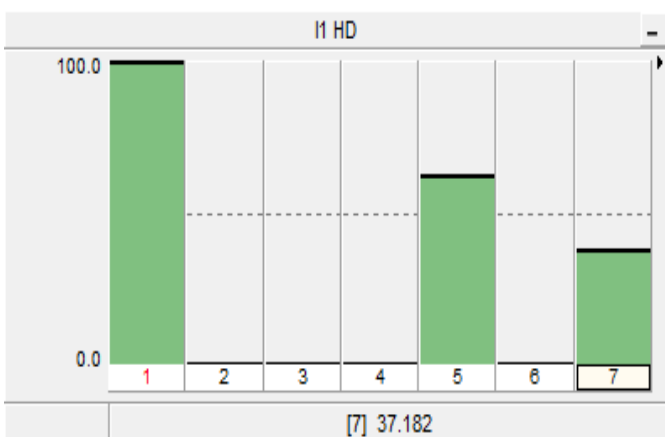

Fig-31b Input Line Current 7th harmonic (120° mode)

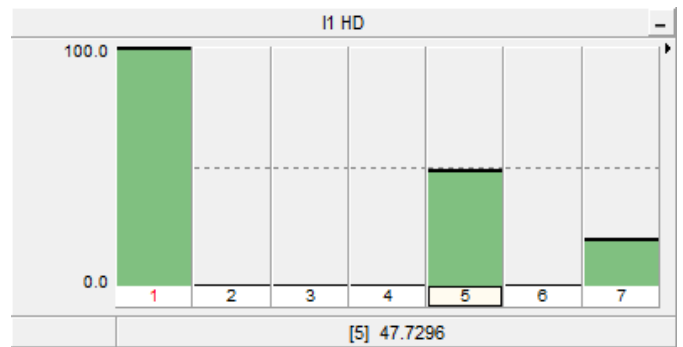

Fig-32a Input Line Current 5th harmonic (150° mode)

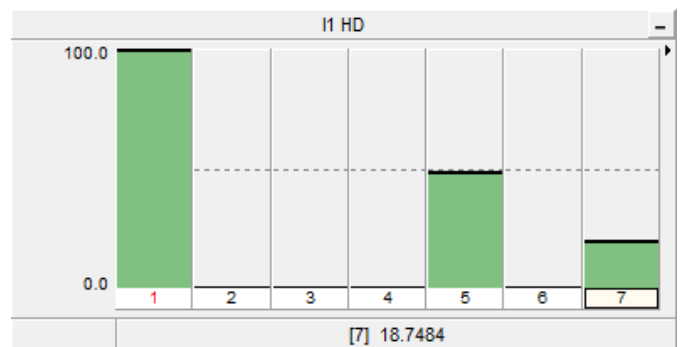

Fig-32b Input Line Current 7th harmonic (150° mode)

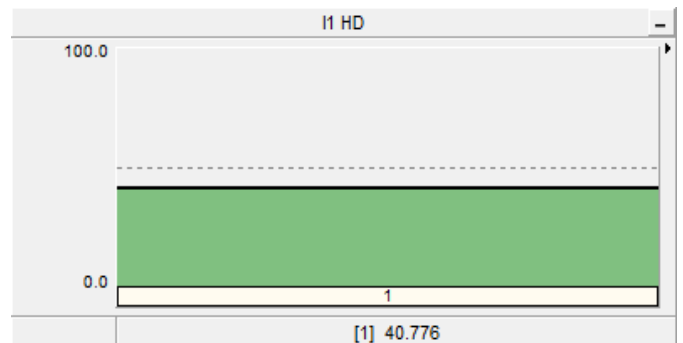

Fig-33 Input Line Current THD (180° mode)

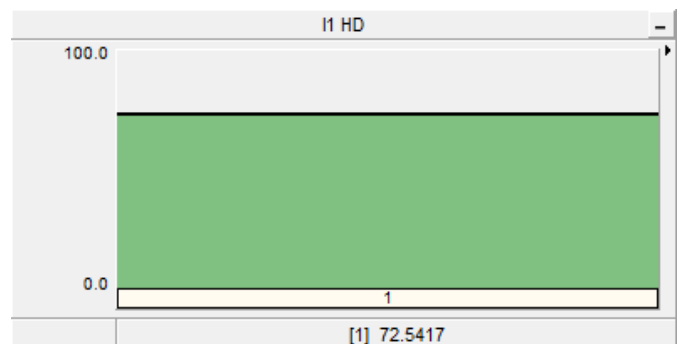

Fig-34 Input Line Current THD (120° mode)

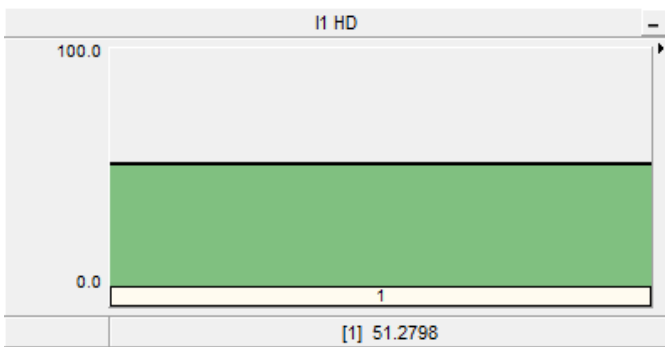

Fig-35 Input Line Current THD (150° mode)

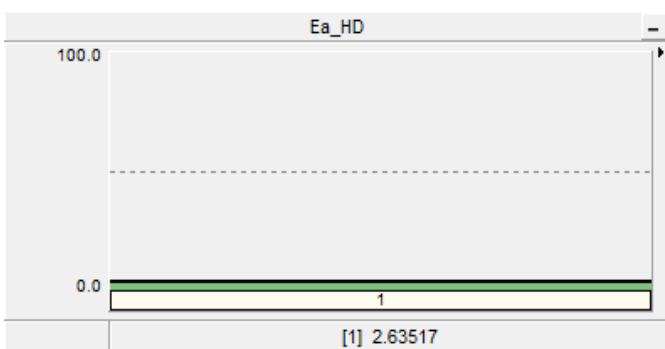

Fig-36 Input Line to Line Voltage E_A (180° mode)

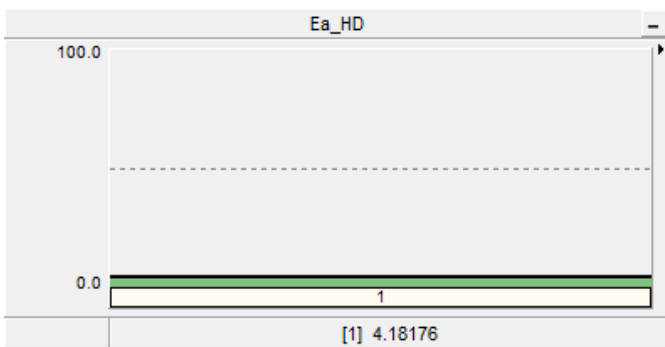

Fig-37 Input Line to Line Voltage E_A (120° mode)

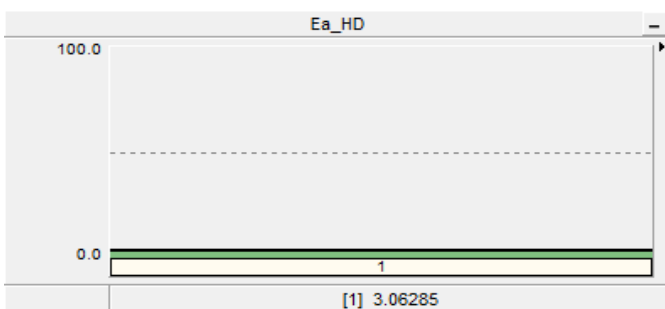

Fig-38 Input Line to Line Voltage E_A (150° mode)

7. CONCLUSIONS

This paper analyse the behaviour of Input current I_1 , Load current I_A , Output voltage V_{AB} and Input Voltage E_A . It is clear from results that there is reduction in THD of the Load current I_A when 3-Phase Bridge Type Inverter is operated at 150° conduction mode i.e. 13.69% and 18.18% compare to 180° and 120° respectively. Similarly, there is reduction in the Output Line voltage V_{AB} by 14.85% and 16.8% compare to 180° and 120° respectively when operated at 150°. On the other hand, Input Line current I_1 THD is minimum when VSI is operated at 180° conduction mode. As nonlinear load are introduced into the power system voltage distortions are created. Current distortions are mostly caused by the load. Thus, these voltage distortions at the input side are created by the injection of harmonic current. Minimum voltage distortion is introduced when VSI operates at 180° conduction mode because of the minimum harmonic input current compare to other conduction mode.

REFERENCES

- [1] M.H. Rashid, "Power Electronics: Circuits, Devices, an Applications", Prentice Hall Inc., 2nd Edition, 1993
- [2] M D Singh and K B Khanchandani, "Power Electronics", Mc Graw Hill Education, 2nd Edition, 2013
- [3] Ghulam Shabir Memona , Mukhtiar Ahmed Maharb, Abdul Sattar Larikb, Anwar Ali Sahitob and Aneel Kumar Maheshwaria "Power Quality Comparison of Three Phase Bridge Inverter Based Induction Motor"
- [4] Ramesh Parmar¹ and V. J. Rupapara² "Three-Phase Voltage Source Inverter with 150° Conduction Mode"
- [5] Mr. Divyeshkumar G. Mangroliya^{1*}, Mr. Vinod J. Rupapara² ,Mr. Rakeshkumar P. Akabari³and Mr. Nirav M. Vaghela⁴ "AN ADVANCED THREE PHASE VSI WITH 150° CONDUCTION MODE USING PIC16F72"