

Analysis of Box Culvert for Storm Water Drainage System for Runway under Aircraft Loading at Airport

Sharad R. Pagar¹, Dr. R. S. Talikoti²

¹PG Student, Department of Civil Engineering, L. G. N. Sapkal College of Engineering, Nashik, Maharashtra, India

²Dr. R. S. Talikoti, Professor & Head, Department of Civil Engineering, L. G. N. Sapkal College of Engineering, Nashik, Maharashtra, India

Abstract - Culverts are required to be provided under earth embankment for crossing of water course like streams, Nallas across the embankment, as road embankment cannot be allowed to obstruct the natural water way. Culverts are also used to balance the flood water on both sides of earth embankment to reduce flood level on one side of road thereby decreasing the water head to reduce the flood problems. Culverts can be of different materials and different shapes as per their use and need. Considering the need of new drainage system at Chhatrapati Shivaji International Airport Mumbai here an analysis Box Culvert for Storm Water Drainage System is made under the aircraft loading.

Key Words: Aircraft Wheel Load¹, Box Culvert², Etab Analysis³, Manual Design⁴

1. INTRODUCTION

A culvert is a structure that allows water to flow under a road, railroad, trail, or similar obstruction from one side to the other side. Typically embedded so as to be surrounded by soil, a culvert may be made from a pipe, reinforced concrete or other material.

It is well known that roads are generally constructed in embankments which come in the way of natural flow of storm water (from existing drainage channels). As such flow cannot be obstructed and some kind of cross drainage works are required to be provided to allow water to pass across the embankment. The structures to accomplish such flow across the road are called culverts, small and major bridges depending on their span which in turn depends on the discharge. The culvert cover upto waterways of 6 m (IRC:5-1998) and can mainly be of two types, namely, box or slab. The box is one which has its top and bottom slabs monolithically connected to the vertical walls. In case of a slab culvert the top slab is supported over the vertical walls (abutments/ piers) but has no monolithic connection between them. A box culvert can have more than single cell and can be placed such that the top slab is almost at road level and there is no cushion. A box can also be placed within the embankment where top slab is few meters below the road surface and such boxes are termed with cushion. The size of

box and the invert level depend on the hydraulic requirements governed by hydraulic designs. The height of cushion is governed by the road profile at the location of the culvert.

For a box culvert, the top slab is required to withstand dead loads, live loads from moving traffic, earth pressure on sidewalls, water pressure from inside, and pressure on the bottom slab besides self-weight of the slab.

2. METHODOLOGY

Such Box-culverts are design under the effect of Aircraft Wheel load for various combinations and the various aircrafts arriving at the airport. The analysis of the box-culvert will be made by using the computer software like Etab under maximum wheel load of Airbus 340- 500/600 and the design will be done manually in the due course of the project.

1.1 Design Basis & Assumptions

- Airside storm water drainage is designed for 1 in 50 year return period and the rainfall intensity is taken as 101.4mm/hr. which is referred from the CWPRS report.
- Time of concentration is calculated from Kirpich's formula and the corresponding rainfall intensities are found out for each stretch of drain.
- The main deciding factor of airside catchment areas are the Taxiways & Runway centerlines and the master grading plan.
- Catchment areas are divided into paved & unpaved areas and the runoff coefficients are 1.0 and 0.35 correspondingly.
- The basic design has been done using Manning's conventional method and then these inputs have been given to modeling software to optimize the sizes of drains.

1.2 Load Calculations:

AIRBUS A340 - 500 / 600, the data concerning the AIRCRAFT loading has been obtained from the document 'Airplane Characteristics For Airport Planning AC', published by the AIRBUS company.

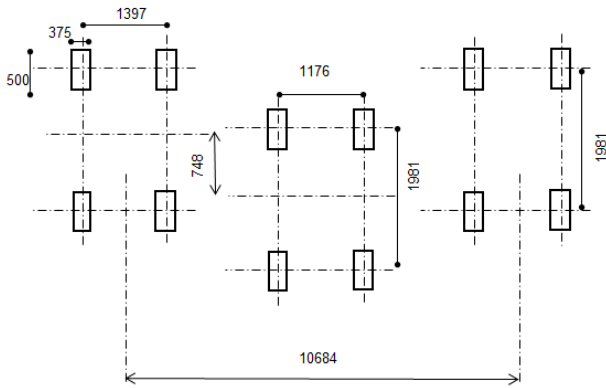

Fig -1: Wheel Configuration of Aircraft A340-500/600

Table -1: Load Calculations under Aircraft Wheel

AIRBUS A340 - 500 / 600	
Tyre Dimensions	500mm X 375mm
Total Weight of Aircraft	370 tonne
95% of weight acts on the wheels on the belly	351.500 tonne
No. of wheels on the belly	12 nos
Load on one wheel	29.292 tonne
Say	30 tonne
Impact Factor	1.5
Factored Weight	45 tonne
Tyre pressure on the wheel (without impact)	1600kN/m ²
Wheel contact area = (a X b) = 0.375m X 0.500m	0.1875m ²
AIR BUS A380	
Tyre Dimensions	400mm X 450mm
Total Weight of Aircraft	565 tonne
95% of weight acts on the wheels on the belly	536.75 tonne
No. of wheels on the belly	20
Load on one wheel	26.8375 tonne
Say	27 tonne
Impact Factor	1.5
Factored Weight	40.5 tonne
Tyre pressure on the wheel (without impact)	1500kN/m ²
Wheel contact area = (a X b) = 0.4m X 0.45	0.18m ²
Soil pressure (Unit weight of soil)	18 kN/m ³
For Rigid pavement: Angle of internal friction (Φ)	30 assumed
Coefficient of lateral earth pressure, Ka = (1-sin Φ / 1+sin Φ)	0.33

Even though the total weight of A380 is more than A340, the load on one wheel is almost same in both the air buses. For A340, the wheel spacing in both directions is lesser than the A380. Hence the critical design forces are due to A340 wheel configuration load.

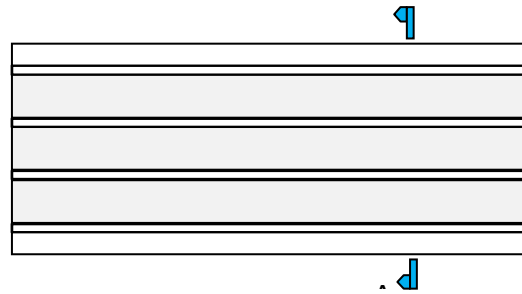

Fig -2: Plan of 3 cell Box Culvert

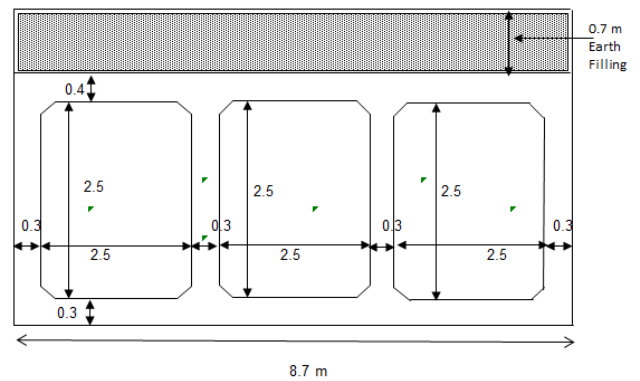

Fig -3: Sectional View

Active Earth Pressure:

Table -2: Calculation of Active Earth Pressure

Depth (m)	Active Earth Pressure	Av. active Earth Pressure on Elements (kN/m ²)
0.700	4.158	
1.200	7.128	5.643
1.700	10.098	8.613
2.200	13.068	11.583
2.700	16.038	14.553
3.200	19.008	17.523
3.700	21.978	20.493

Pressure due to Earth Cushion

Soil pressure -
Considering unit Weight of soil= 16.800 kN/m³

Load Dispersion

Table -3: When front two wheels of A340-500/-600 of wing landing Gear are applied at one end of slab

Width of dispersion on one side at 0.7m depth (1/1.4)X1.0	0.500
Area of dispersion at 700 mm depth	3.827 m ²
Pressure at 700 mm depth (2X300/5.744)	156.80 kN/m ²
Impact factor for a depth of 0.7 m earth cushion	1.1 (AS-3725 Table-2C)
Pressure with impact factor	72.48 kN/m ²

Table -4: When any two wheels of A340-500/-600 of body landing Gear are applied at center of slab for maximum bending moment condition

Assumed load dispersion	1H:1.4V
Width of dispersion on one side at 0.7m depth (1/1.4)X0.7	0.500
Area of dispersion at 700 mm depth	4.1580 m ²
Pressure at 700 mm depth (2X300/6.169)	144.300 kN/m ²
Impact factor for a depth of 0.7 m earth cushion	1.1 (AS-3725 Table-2C)
Pressure with impact factor	158.73 kN/m ²

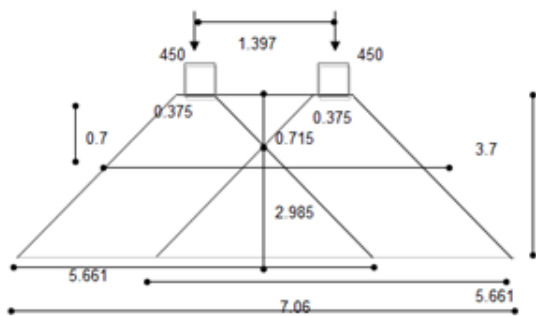

Fig -4: Load Dispersal Diagram for Wing Gear

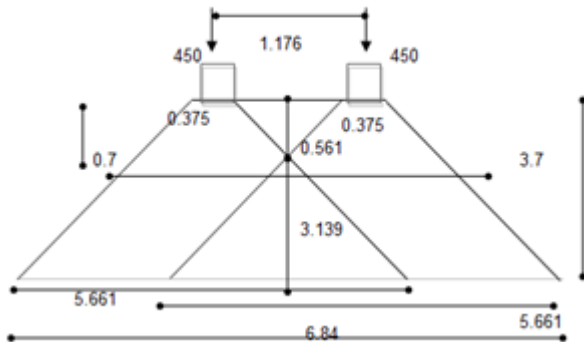

Fig -5: Load Dispersal Diagram for Centre Gear

CASE - 1 Front Wing Gear Wheels Touch the Front Wall of Drain

Surcharge due to wheel load

Single Wheel Load = 300.00 kN

Wheel Load (N) with Impact Factor 1.5 = 450.00 kN

From Reynolds Handbook, Page No. 135, Table No. 20C
Lateral Pressure due to Surcharge,

'qch' at any depth 'h' = $ka \times N / [d + (b/2) + h][2h + a]$

Wheel contact area of Aircraft = 500mmX375mm

a = 0.375m, b = 0.5m, d1 = 0.25m
d2 = 1.0m & d3 = 2.230m

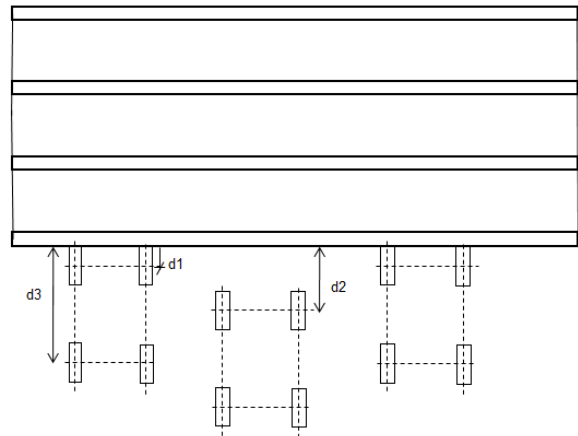

Fig-6 Load Case 1: Front wing gear wheels touch the front wall of drain

Table -5:

For Front Wall Depth	Pressure (P1) kN/m ²	Pressure (P2) kN/m ²	Pressure (P3) kN/m ²	Average Pressure
0.700	139.44	0.00	0.00	NIL
1.200	62.96	43.68	0.00	123.04
1.700	35.76	26.67	0.00	84.54
2.200	23.04	18.03	6.65	55.07
2.700	16.07	13.02	4.96	40.88
3.200	11.85	9.85	3.86	29.81
3.700	9.10	7.72	3.09	22.73

Similarly following Load Cases are done to get the various Average Pressure

ii	CASE - 2	Front Wing Gear Wheels Concentric to Front Wall of Drain
iii	CASE - 3	Front Center Gear Wheels Concentric to Front Wall of Drain
iv	CASE - 4	Rear wing Gear Wheels Concentric to Wall of Drain
v	CASE - 5	Rear Centre Gear Wheels Concentric to front Wall of Drain
vi	CASE - 6	Centre of Rear Gear Wheels at dist. 0.45 m from center of front wall of Drain
vii	CASE - 7	Centre of Rear Body Gear Wheels Concentric on first slab of Drain
viii	CASE - 8	REAR WING GEAR WHEELS CONCENTRIC ON MIDDLE WALL OF DRAIN

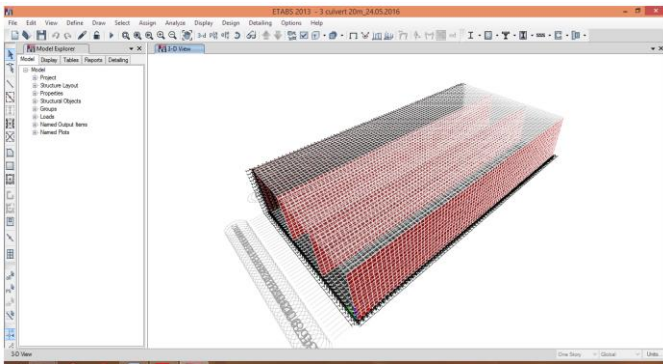

Fig.-7 Box Culvert Model

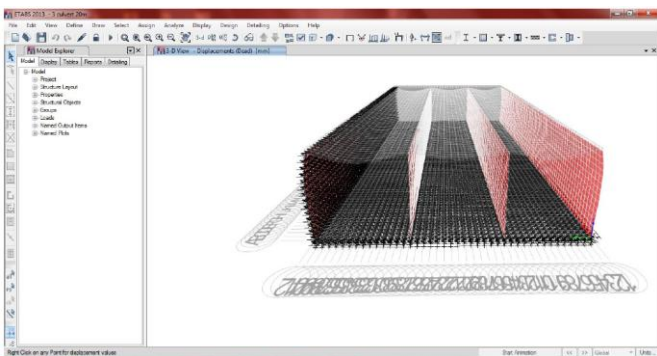

Fig.-8 Deformed Shape 3D View

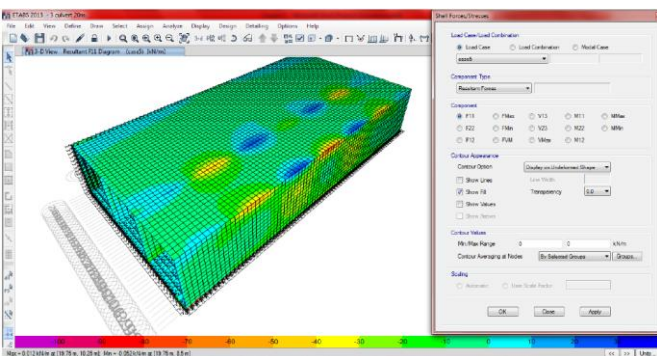

Fig.-9 Stress Diagram

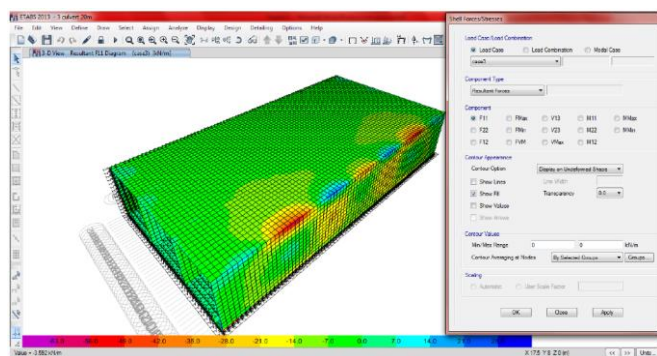

Fig.-10 Shell Member forces and Stress Diagram

3. RESULTS AND CONCLUSIONS

Factored force results from finite element analysis i.e. Etap Analysis

Member	Load Combination	BM (kN-m)	SF (kN)
Base Slab	6	-	144.00
Along Drain Width	6	54.00	-
Support Moment	6	96.00	-
Across Drain Width	5	11.00	-
Support Moment	6	20.00	-
Wall Outer Horizontal	1	17.00	-
Vertical Span Moment	1	66.00	-
Support Moment near Cover Slab	7	39.00	-
Support Moment near Base Slab	1	71.00	-
Wall inner Horizontal	1	21.00	-
Support Moment near Cover Slab	1	71.00	-
Support Moment near Base Slab	1	71.00	-
Cover Slab Along Drain Width	6	118.00	-
Span Moment	4	107.00	-
Support Moment	4	107.00	-
Across Drain Width			
Span Moment	6	54.00	-
Shear Force	6	-	242.00

From the above results it can be concluded that the box culvert can be designed for the highest analytical values i.e. Bending Moment as 118.00 kN-m and Shear Force as 242.00 kN. Depending upon these designed values box culvert can be further design manually.

REFERENCES

- [1] Ahmed A.O.M., Alarabi, E.H., "Development Formulation for Structural Design of Concrete Box Culverts", Paper No. 25, Page No. 164-171, Practice Periodical on Structural Design and Construction © ASCE / May-2011.
- [2] Gholam Ali Shafabaksh, Ehsan Kashi, "Effect of Aircraft Wheel Load and Configuration on Runway Damages", Page No. 85-94, Periodica Polytechnica Civil Engineering, Revised July 2014.
- [3] Kyungsik Kim, Chai H. Yoo, "Design Loading on Deeply Buried Box Culverts", Page No. 20-27, Journal of Geotechnical and Geoenvironmental Engineering © ASCE / January-2005
- [4] Michael G. Katona, "Seismic Design and Analysis of Buried Culverts and Structures", Page No. 111-119, Journal of Pipeline Systems Engineering and Practice © ASCE / August 2010
- [5] Ping Zhu, Run Liu, Wenbin Liu, Xinli Wu, "Study of Optimal Design of a Box Culvert under Road", Page No. 614-618, Civil Engineering and Urban Planning 2012 (CEUP2012) © ASCE 2012
- [6] Raju Acharya, Hie Han, James J. Brennan, Robert L. Parsons, Deepkumar Khatri, "Structural Response of a Low fill Box Culvert under Static and Traffic Loading", J. Perform. Constr. Facil © ASCE

- [7] Sinha, B.N., Sharma, R. P., "RCC Box Culvert – Methodology and Designs Including Computer Method", Paper 555, Page No. 191-219, Journal of the Indian Road Congress, October-November 2009
- [8] Yanjun YANG, Junling WEI, Shuo Wang, "Computer Simulation of the Spatial Attitude of the Box – Culvert under Pass of the Airport Taxiway", Page No. 3036-3042, CICTP 2012 © ASCE 2012.