

Development of Multilevel Inverters for Control Applications

Jaya Sree.Lavydya¹, Farzana Sayeeda²

^{1,2} Asst Prof, Dept of EEE, Cristhu Jyothi Institute of Technology & Science, Telengana ,India

Abstract— *In the aspect of industrial automation, inverter plays a vital role in developing drives. With two-level voltage source inverters to obtain a quality output voltage or a current waveform with a minimum amount of ripple content they require high switching frequency along with various pulse width modulation (PWM) strategies. In high power and high voltage applications these two-level inverters have some limitations in operating at high frequency mainly due to switching losses and constraints. The multilevel inverters have drawn tremendous interest for high voltage and high power applications. This paper proposes design and implementation of the sinusoidal pulse width modulation (SPWM) and multilevel technique to reduce the harmonics. In developing this technique, intelligent systems is proposed to improve their performance. The performance of the proposed technique will be compared with standard existing techniques. The design and development of multilevel techniques will be carried out in Matlab/Simulink environment.*

Key words— CHMLI, SPWM, NN

1. INTRODUCTION

From last decades, the multilevel inverters have drawn tremendous attention in the field of high voltage and high power applications. In the researches on multilevel inverters, determination of their respective control strategies is the emerging topic. Modern power electronics based devices have put a great effect on the development of new powerful applications and industrial solutions. But at the same time, these advances have increased the harmonic problems in line currents, which make distortion in the voltage waveforms. Diode power rectifiers, thyristor converters and static VAR

compensators (SVCs) are examples of power electronics applications [6]. The series connection of several bridges allows working with much higher voltages and the stepped voltage waveforms to eliminate the voltage stress in associated equipment, such as transformers [5]. Moreover, the bridges of each converter work at a very low switching frequency which allows working with low speed semiconductors and low switching frequency losses.

Filters are used for compensation of contaminating load with small power factor and to feed the load during voltage dips. The multilevel inverters perform power conversion in multilevel voltage steps to obtain improved power quality, lower switching losses, better electromagnetic compatibility and higher voltage capability. Considering these advantages, multilevel inverters have been gaining considerable popularity in recent year.

2. MULTILEVEL INVERTERS

2.1 Types of Multilevel Inverters

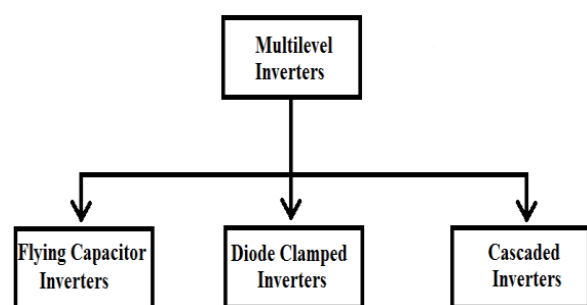

Fig - 1: Classification of multilevel inverters

In Figure 1 different types of multilevel inverters are given. Each multilevel inverter contains different features and different control schemes and different structures in themselves. Multilevel inverter topologies are classified into three categories diode clamped inverters, flying capacitor inverters and cascaded inverters [1]. In Diode clamped inverters clamping diodes per phase, DC bus capacitors, power semiconductor switches are presented. In flying capacitor inverters power semiconductor switches, DC bus capacitors, balancing capacitors per phase are presented. In cascaded inverters DC bus capacitors, power semiconductor switches are presented.

2.2 Comparison of Multilevel Inverter Topologies

Total Harmonic Distortion of output voltage. Amplitude of fundamental and dominant harmonic components. Number of semiconductor devices used per phase leg. Control complexity based on voltage unbalances and power switches [2]. Number of balancing capacitors used per phase leg. Number of DC bus capacitors used.

Cascaded inverter requires the least number of components to achieve the same number of voltage levels in comparison with diode clamped and flying capacitor inverters. The implementation costs of the FCMLI and CMLI are almost same but it is fifteen percentages lower than that of DCMLI. It is found from above comparison that the cascaded multilevel inverter topology is the most promising one. Cascaded inverters provide a compounding of voltage levels leads to lower harmonic distortion avoids single isolated voltage sources and constructed with the low rating power devices which are commercially market ready [3].

2.3 Advantages of Multi Level Inverters

In general, multilevel power inverters can be view as voltage synthesis in which the high output voltage is synthesized from many discrete small voltage levels, main advantages of this approaches are summarized as follows.

The voltage capacity of the exciting devices can be increased many times without the complication of static and dynamic voltage sharing that occurs in series connected devices. Spectral performance of

multilevel wave forms is superior to that of the two level counter parts. Multilevel wave forms naturally limit the problems of large voltage transient that occur due to the deflections on cables, which can damage the motor winding cause other problems. To decrease the THD value [4].

3. CONVENTIONAL CONTROL OF MULTILEVEL INVERTER

3.1 Five-level Cascaded H-bridge Multilevel Inverter

This inverter is operated with $V_{dc} = 2V$. Figure 2 shows the circuit diagram of five-level cascaded H-bridge multilevel inverter simulation model. The pulse pattern for the circuit is generated by using the sinusoidal pulse width modulation.

The output responses of model which are voltage and current waveforms and their THD spectrums are shown in Figure 3,4,5 and 6 respectively.

4. NEURAL NETWORK CONTROL OF MULTILEVEL INVERTER

CHMLI block as shown in Figure 7 consist of five H-Bridges inverters. IGBT power electronic devices use as the switching components. Hence in this CHMLI consist twenty IGBT with similar type, and five separated DC sources with equal amplitude. Input signals that entrance to NN have to normalized, and for output signal that exit from NN have to denormalized. Amount layers and neurons in the each layer determined by optimization, where the optimum condition occurs if the NN system has little amount of neuron but have lowest error rate.

The implementation of the feed forward neural network based SPWM is interesting. The design of the feed forward neural network proposed in this work consists of three layers. The neural network used has one input neuron. The feed forward neural network accepts reference signal as input. Here we have twenty hidden neurons which have to be tested and feed forward neural network has tansigmoid characteristics. And the neural network has five output neurons which gives pulses as output the pulses which are generated are given to CHMLI [7].

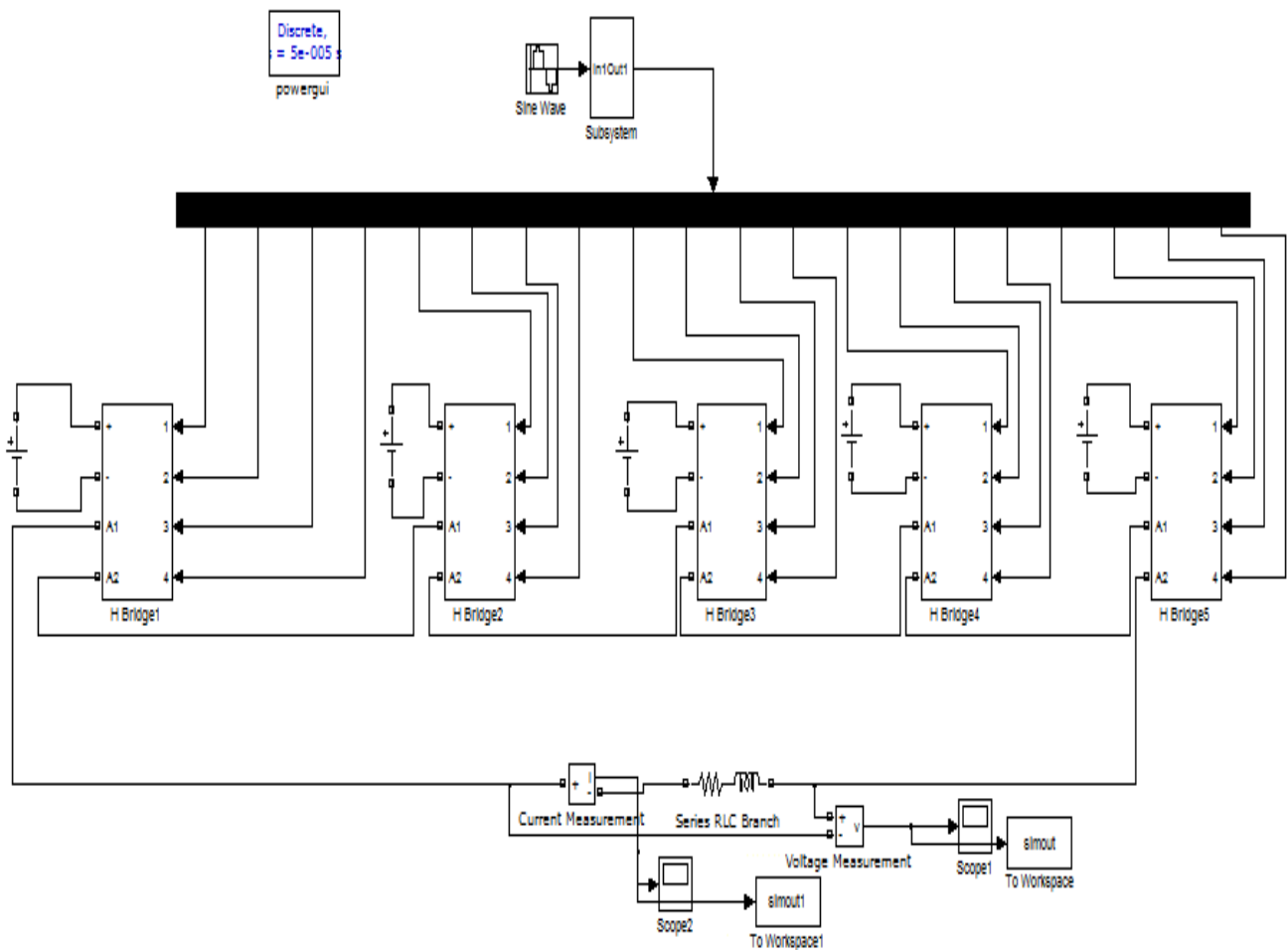

Fig -2: Five-level cascaded H-bridge multilevel inverter simulink model using SPWM

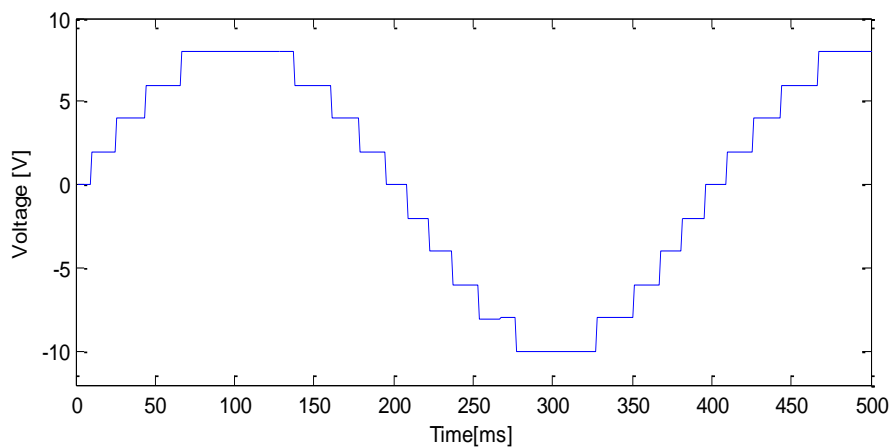

Fig -3: Five-level CHMLI output voltage waveform

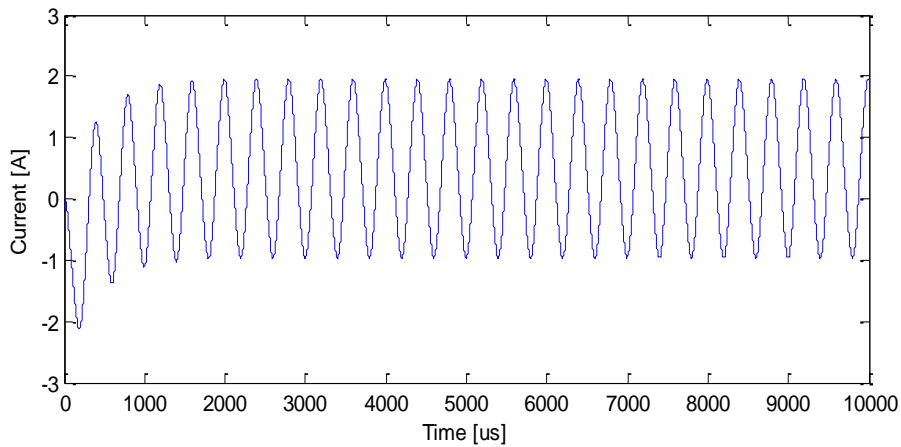

Fig -4: Five-level CHMLI output current waveform

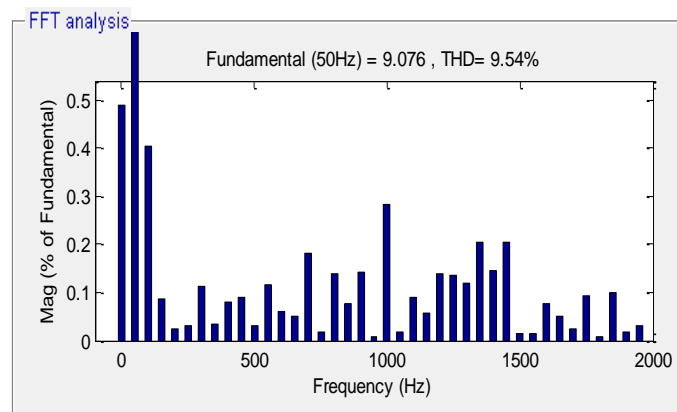

Fig -5: THD Spectrum of Five-level CHMLI output Voltage waveform

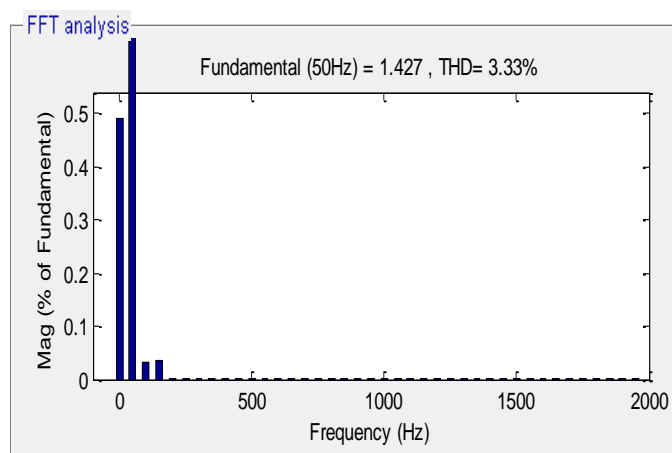

Fig -6: THD Spectrum of Five-level CHMLI output Current waveform

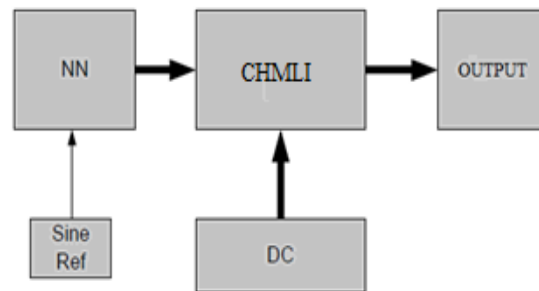

Fig -7: Block diagram of neural network controlled multilevel inverter

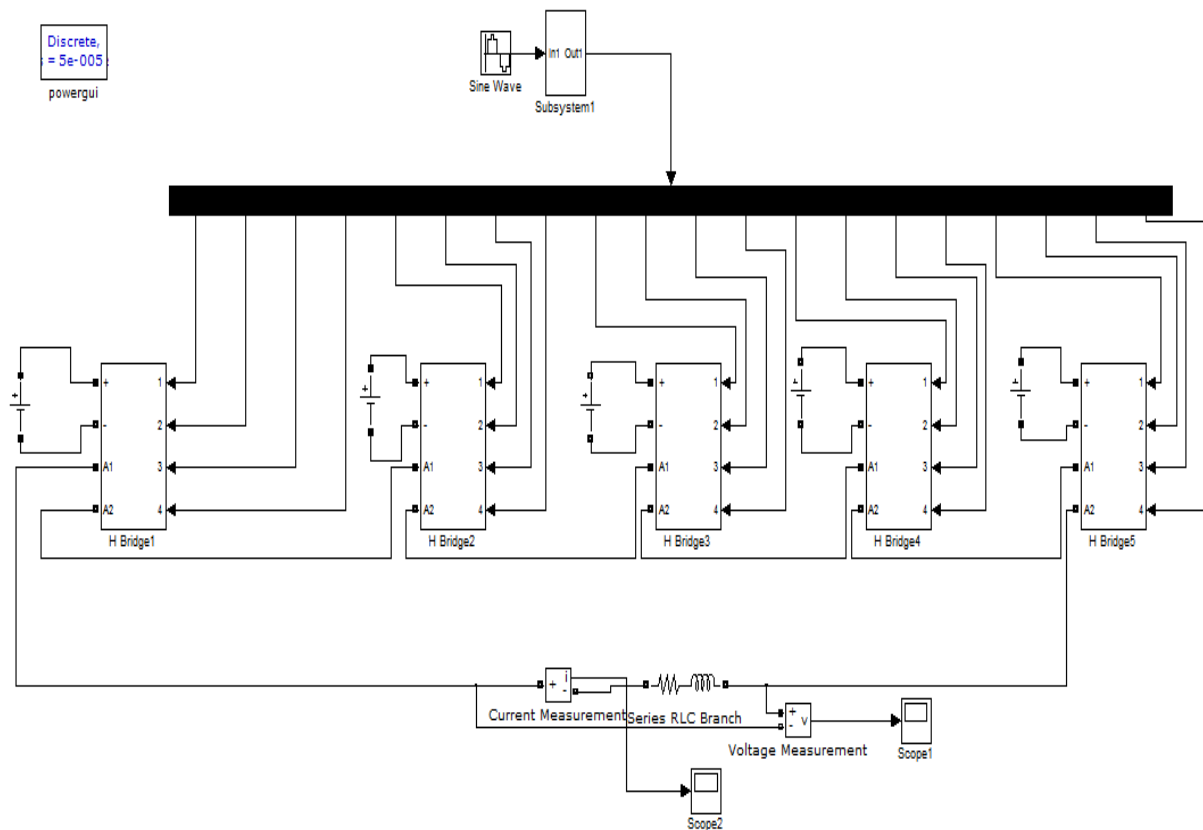

Fig -8: Five-level CMHLI using NN controller operating at $V_{dc} = 2V$

4.1 Five-level Cascaded H-bridge Multilevel Inverter using NN Controller

The five-level CHMLI using NN controller simulation model circuit diagram is developed as shown in Figure 8 and the inverter is operated with $V_{dc} = 2V$.

CHMLI consist of five H-Bridges inverters circuit as shown in Figure 8 uses IGBT power electronic device as the switching components. Hence in this CHMLI consist twenty IGBTs with similar type, and five separated DC sources with equal amplitude. Input

signals to Neural Network have to be normalized, and output signal of Neural Network have to be denormalized. Total Amount of layers and neurons in the each layer determined by optimization, where the optimum condition occurs if the NN systems have little amount of neurons but have lowest error rate. The NN controller trained by their inputs. The output pulse signals which are generated from this neural network are given to CHMLI. Performance of training process in the graph format is shown in Figure 9. This figure indicate that training have small error.

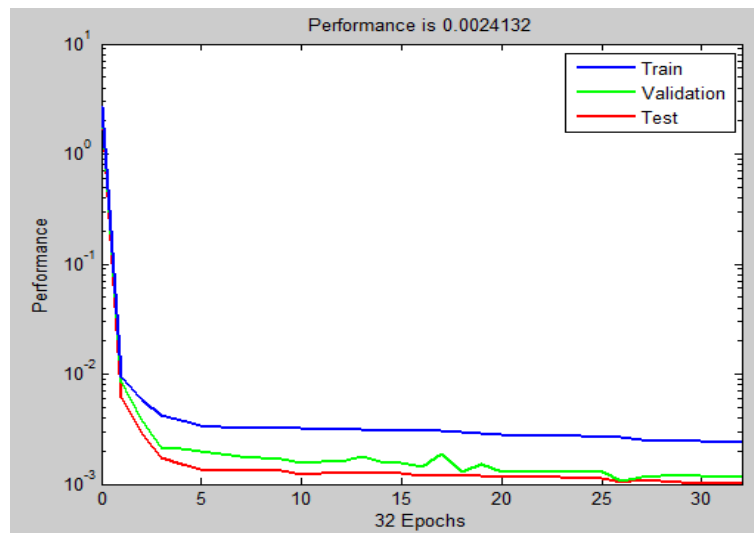

Fig -9: Performance of training process

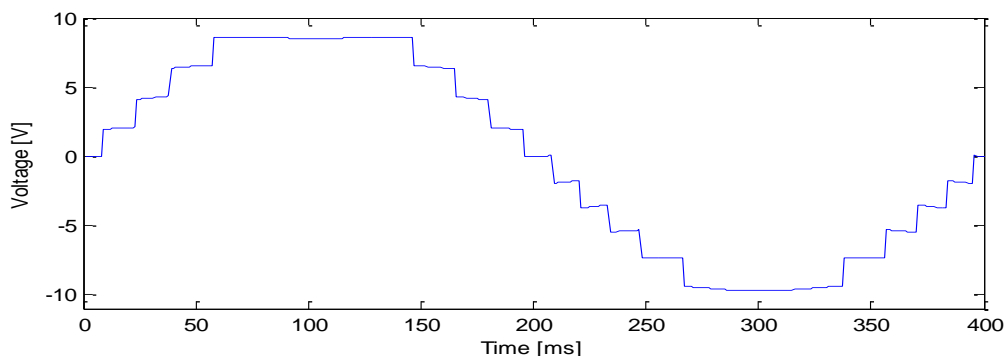

Fig -10: Output voltage waveform of five level CHMLI using NN controller

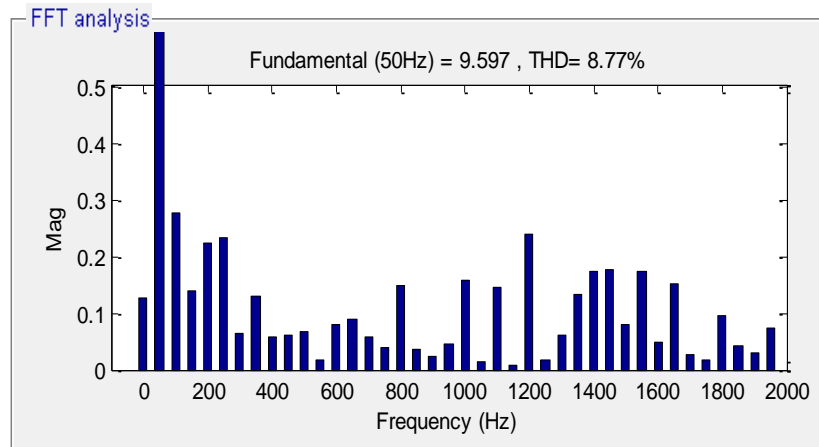

Fig -11: THD spectrum of voltage waveform of five level CMHLI using NN controller

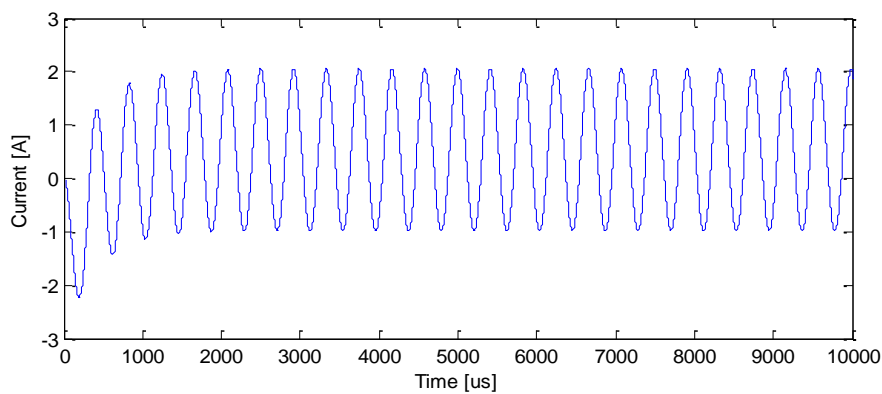

Fig -12 : Output current waveform of five level CHMLI using NN controller

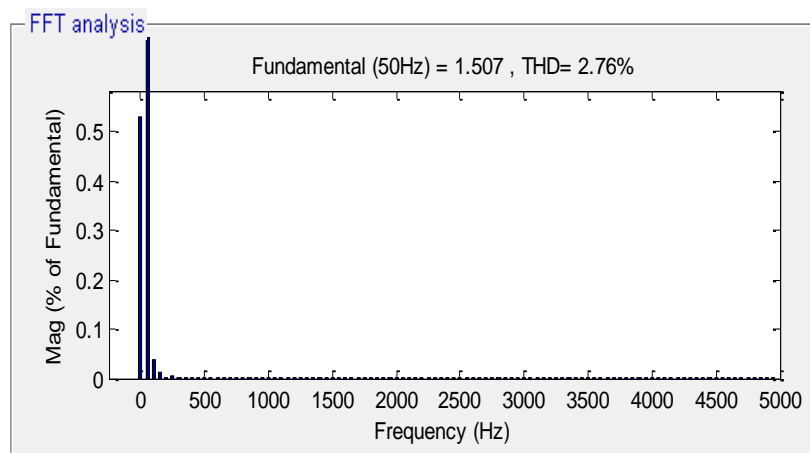
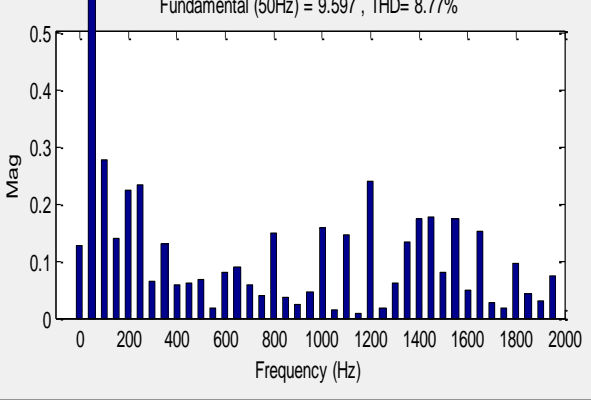

Fig -13: THD spectrum of current wave form of five level CHMLI using NN controller



own in figures 10 and 12 and the THD
2.76% respectively as shown in Figure11 and 13

Table -1: Comparison of THD of multilevel Inverters with and without NN controller

Five-level MLI	Voltage THD in %	Current THD in %
Conventional CHMLI	9.54	3.33
CHMLI using NN controller	8.77	2.76

THD of CHMLI using NN controller is further more decreased than the conventional five-level inverter.

Here comparison of the conventional and neural network based multilevel inverter performances by considering the THD parameters is given in table 5.1.

From the comparison table it can conclude that neural network based multilevel inverter has better performance than conventional multilevel inverters.

6. CONCLUSION

In this paper multilevel inverter using intelligent technique has been developed namely artificial neural networks is used to realize the proposed technique. The multilevel inverters simulink models are developed using matlab software. The three-phase five level diode clamped multilevel inverter is developed using sinusoidal pulse width modulation. Three phase five-level cascaded multilevel inverter is developed using sinusoidal pulse width modulation and five-level cascaded multilevel inverter using neural network controller are developed and there results are compared. The multilevel inverter which uses neural network has better performance than conventional one. From the results it is observed as the level increases THD is decreased. Five-level cascaded multilevel inverter which is using neural network controller results in 2.76% THD. Neural based MLI compared with conventional MLI gives better performance.

REFERENCES

[1] F.Z.Peng, J.S Lai, "Multilevel Converters", IEEE Transactions on Industry Applications, Vol.32 No.3, May/June, pp.509-517.

[2] A. Nabae, I. Takahashi, H. Agaki, "A New Neutral-Point-Clamped PWM, Inverter," IEEE Transactions on Industry Applications. Vol.IA-17, No.5, Sep / Oct, 1981, pp.518-523.

[3] P. M. Bhagwat and V. R. Stefanovic, "Generalized Structure of a Multilevel PWM Inverter," IEEE Transactions on Industry Applications, Vol.IA-19, No.6 Nov.Dec., 1983, pp.1057-1069.

[4] Mohammed H. Rashid. "Power Electronics" Prentice-Hall of India Private Limited, Second Edition, 1994(Book).

[5] Richard Lund "Multilevel power electronic converters for electrical motor drives" Doctoral thesis at NTNU 2005:62.Trondheim April 2005.pp 19.

- [6] J. Rodriguez, S. Bernet, B. Wu, J. Pontt and S. Kouro, "Multilevel voltage-source-converter topologies for industrial medium-voltage drives," IEEE Trans. Ind. Electron., vol. 54, no. 6, pp. 2930–2945, Dec.2007.
- [7] Basil M. Saied , Qais M. Alias, "Intelligent Systems based Selective Harmonic Elimination (SHE) for Single Phase Voltage source Inverter" University of Mosul Vol.16 No.3Aug.2008.